

The background of the entire page is a close-up photograph of a wooden workbench. It features various pieces of wood, some with visible grain, and several hand tools including a hammer, a chisel, and a square. The lighting is warm, highlighting the textures of the wood and the metallic parts of the tools.

**VALLEY OAKS CHARTER SCHOOL**

# **BASIC WOODWORKING**

**Safety  
Joinery**

**Drafting  
Finishing**

**Measuring  
Work Ethic**

**WELCOME:**

Expectations	Prompt writing	Evaluations
Oral presentation		

**UNIT 1: SAFETY**

General Shop Safety I	General Shop Safety II	Hand Tools
Power Tools	Woodworking Terminology	

**UNIT 2: DRAFTING**

Introduction to Drafting	Multi-view drawings	Line Type and Quality
Dimensions and Notes	Sections	

**UNIT 3: MEASURING**

How to Measure	Measuring Terminology	True Size
----------------	-----------------------	-----------

**UNIT 4: JOINERY**

Introduction to Joinery	Squaring Wood	Metal Fasteners
Rods and Splines	Clamping and Gluing	

**UNIT 5: FINISHING**

Surface Preparation	Friends and Foes	Wood Staining
Top Coating	Oil and Wax	

**UNIT 6: WORK ETHIC**

Introduction to Work Ethic	Work Ethic Standards	I-Management
Stress Management		

## EXPECTATIONS

### **Introduction**

The Woodworking Department of Valley Oaks Charter School exists to partner with parents by helping students reach their fullest potential as:

*Academic Achievers* who have a passion for life-long learning.

*Effective Communicators* who demonstrate competence in oral, written, illustrative, and artistic communication.

*Critical Thinkers* who can analytically read construction plans, build woodworking projects, and prepare wood surfaces for finishing material.

*Literate Operators of Technology* who efficiently, effectively, and safely utilize woodworking equipment to produce useable products.

*Culturally Aware Citizens* who considerately and selflessly work with others.

*Motivated, Self-Directed People* who strive to learn and apply goal setting techniques, organize and manage time efficiently, and assume personal responsibility for planning, constructing, and finishing woodworking projects.

### **Teaching Method:**

To help each student reach his or her fullest potential, we employ the LEARN method of instruction, which is an acronym that stands for Listening, Examining, Applying, Researching, and Notifying. That is to say, students will learn by:

**L**istening to information taught in class

**E**xamining classroom demonstrations and methods of woodworking techniques

**A**pplying what is learned by building woodworking project(s)

**R**esearching outside articles to further gain knowledge on given subject matter

**N**otifying others what has been learned through written responses, group collaborations, and oral presentations.



## **EVALUATIONS**

---

### **Introduction**

To further help students comprehend the subject matter presented in this text and the corresponding lab work they are required to prepare for evaluations by reviewing the material, processing it, and presenting what they learned to the instructor. A list of evaluations and a brief description are below.

### **Daily Evaluations:**

Developing a good work ethic is very important. Students will receive daily work ethic grades based on their diligence, behavior, and cooperation in class.

### **Unit tests:**

Unit tests are multiple choice questions pulled directly from the text.

### **Group tests:**

The students work together to solve a problem presented to them by the instructor. After they choose the role each will play on the problem solving team (facilitator, presenter, secretary, messenger, researcher, illustrator, and problem solver), the students pull together their combined knowledge to develop a solution. Each member of the team receives the same grade for the presentation. Individual participant scores are given by the students after a peer evaluation.

### **Project Evaluations:**

Student projects will be evaluated accordingly. Please see the “project evaluation form” in the appendix for further detail.

25% = Project Preparation/Drafting Plans

25% = Project Construction

25% = Finish (sanding, stain, topcoat, wax, etc.)

25% = Work Ethic



## Unit I



**General Shop Safety**

**Hand Tools and Power Tools**

**Tool Certification**

**Virtues of Woodworking**

**Woodworking Terminology**

# safety

## Unit Prompts

Answers to prompts must include one reference from the class text and one reference from an internet article (dictionary and encyclopedia resources will not be accepted). Be sure to put quotation marks around your citations, number them, and place footnotes at the bottom of your paper to reference where your citation came from.

*Prompt 1: In 150 words, explain the number one cause of accidents in the woodshop and why it occurs. How can you avoid it happening to you?*

*Prompt 2: In 150 words, look over the Ten Commandments of Machine Safety as found in this text. Place the commandments in order of most important to least important. Explain your reasoning.*

*Prompt 3: In 150 words, explain three ways people put themselves in danger while working in the woodshop and three ways they put others in danger while working in the woodshop. Also, list the purpose, warning, and major cause of accident for each of the following: miter saw, drill press, table sander, and scroll saw*

*Prompt 4: In 150 words, explain how impatience and hurrying to finish a task can be your worst enemy. Explain how the virtues of patience, peace, and self-control will help you?*

*Prompt 5: Write the definition for the following woodworking terms:*

<i>Board Face</i>	<i>Board Edge</i>	<i>Board End</i>	<i>Fence</i>
<i>Grain</i>	<i>Grit</i>	<i>Kerf</i>	<i>Warp</i>
<i>Clamp</i>	<i>Square</i>	<i>Paint thinner</i>	<i>Joint/joinery</i>
<i>Countersink</i>	<i>Kick-back</i>	<i>With the grain/Across the grain.</i>	
<i>Rip Cut</i>	<i>Crosscut</i>		



## Chapter 1

**General Shop Safety****Introduction:**

The following shop safety rules have been put in place for student safety while working in the Valley Oaks Charter School (VOCS) woodshop. Please read the entire safety manual found in the appendix of this book. All safety rules must be followed COMPLETELY by ALL students. Those students who do not follow the safety rules will be dropped from the class and not allowed to re-enter.

After completing the General Safety Exams with 100% accuracy, the student shall be considered *Shop Safety Certified* and given the privilege of working in the VOCS woodshop. He or she must at that time receive parental permission authorizing him/her to use power machinery (see CONSENT TO USE POWER TOOLS in the appendix). Though no student will at any time be forced to use power tools, neither will he or she be permitted to use power tools unless the CONSENT TO USE POWER TOOLS form is properly signed and on file with VOCS. Once the form has been filed, the student will receive instruction regarding woodshop machinery. Only after a student has become tool certified on a given piece of machinery will he/she be allowed to work on that machine. This is accomplished only after the teacher has shown the student the proper and safe way to use a piece of equipment and the student passes the *Tool Certification Test* with 100% accuracy. Still, every time a student wishes to use a machine, he/she must get permission from the instructor.

**“Always Think Safety”**

*All accidents can be prevented with common sense and attention to the safety rules.*

**A. Proper Personal Protective Equipment**

1. Required safety gear
  - a. Safety glasses: Students must wear safety glasses at all times while in the woodshop area to prevent flying particles or corrosive substances (stain, lacquer, oils, etc) from entering their eyes.
2. Required safety dress code:
  - a. Nothing loose. Tie up, roll up, fasten, or remove any loose clothing, long sleeves, scarves, jewelry, and hair. Such items are easily caught in moving parts and can cause serious injury.
  - b. Do not wear rings, watches, sweaters, loose long sleeve shirts, etc., as this will increase chances for an accident as such items could get caught in the equipment
  - c. Flat no-slip shoes that cover the top of your feet and toes must be worn. Such shoes prevent slipping and help avoid toe injuries.
  - d. Recommended personal protective equipment: It is recommended that students wear ear plugs/muffs and a dust mask. It is also recommended students wear goggles and a face shield for those operations that throw a lot of wood chips.
  - e. **DO NOT WEAR GLOVES** when operating rotating or reciprocating machines. Gloves hinder the ability to effectively use your hands and may get caught in moving machinery.



Safety Glasses



Face Shield



Dust Mask



Ear Muffs

**B. Proper Preparation**

## 1. Project planning:

- a. Plan the work and work the plan. Come to the woodshop prepared and have a clear plan of what you will be doing. Doing so helps you keep your mind on what you're doing.
- b. Think it through. Know what operations you will be performing, the order in which you will be doing the work, and how you are going to make the cut. Know what you are going to do, and how you are going to do it **BEFORE** you begin. If you are not certain, ask for help. Rehearse cuts before cutting. Measure twice, cut once.
- c. Tool Certification: You must be certified to use a piece of machinery before using it. A written and oral safety test must be passed with a 100% accuracy before being certified.

## 2. Attitude:

- a. Come with an attitude to work and to work safely. The number one cause of accidents is "not paying attention." Keep your mind on your work.
- b. You **MUST NOT PLAY, CLOWN AROUND, or RUN** in the shop area. Do not tamper or play with tools. What I mean is no horseplay or you will be dropped from the class.
- c. Always keep your mind on your work and do not talk to others while operating equipment. Talking with others can result in an accident. If your mind is on someone else, it is not on your work.
- d. Be patient, kind, and courteous. Do not rush your work or the work of the person using the machine for which you are waiting. Do not crowd or hurry a person at a machine. A distracted worker is an accident waiting to happen.
- e. Think safe, feel safe: You are under no obligation to use power tools or machinery. If you do not feel safe using a certain tool, do not use that tool. Similarly, if you are in any doubt about how to use a piece of machinery or the cut you plan to make, inform the instructor.
- f. Never talk to or distract a student using a machine. Such distractions can cause serious injury. You must stand outside the yellow lines when the area is occupied by a user.
- g. Never allow yourself to be distracted while using a machine. If someone talks to you, ignore them, finish your cut, turn off the machine, wait for the blade to stop, and then address them. Never turn on a machine when someone else is inside the yellow lines with you.
- h. If you feel ill or are on any medication that could impair your ability to work safely, inform the instructor. Moreover, if your mind is "elsewhere" (problems at home, relational issues, worry, stress, etc.), do not work on machinery. Rather, perform work that is not dangerous, such as drafting, organizing, sanding, staining, or cleaning.
- i. Report any injury to the teacher immediately, no matter how small the injury is.
- j. We are here to work hard and efficiently. Do not sit on workbenches or machinery.

## 3. Wood selection:

- a. Only material furnished or approved by the instructor is to be used.
- b. All material is to be inspected for knots and nails before using. These may fly off during cutting and cause bodily injury or damage the machine.
- c. Do not use green lumber in any milling process. Green lumber is wood that has not been thoroughly dried. It is wet on the inside and contains tree sap. This type of wood will change over time (warp, bow, twist, etc.) as well as grow mold.

**C. Proper work environment**

## 1. Cleanliness

- a. It is every student's responsibility to clean the shop at the end of class.
- b. Keep the floor clean and free of scrap material, sawdust, oil, wax, and grease. Such messes cause slips, trips, and falls. If you see it, it is up to you to clean it! No "step-overs."
- c. Keep work areas clean. Messy work areas are unsafe areas. Always use a hand brush to clean up scrap material, shavings, and sawdust. Never use your hand.
- d. Always wait for moving parts (blades, drill bits, sanding discs, etc.) to come to a complete stop before removing scrap material or saw dust. Moving parts, no matter how slow, are still a danger.
- e. Put away leftover wood immediately. Do not leave scrap material behind for someone else to move out of their way. Put away your own material.
- f. Place electrical cords and vacuums out of the path of travel. To avoid tripping accidents, make certain electrical cords are flat on the floor and not suspended in the air.
- g. Clean paint brushes immediately after using. Put used rags in the proper container.
- h. Keep your behavior clean: Absolutely no vulgar, crude, or rude behavior will be tolerated. That means no cussing (including the misuse of religious names of God, prophets, or priests), no coarse joking, and no inappropriate touching or show of affection. It means to respect one another, and for guys to HONOR THE GIRLS with admirable actions.
- i. Report all breakage or damage to tools or machinery to the instructor immediately. Moreover, if a machine is running poorly, making an unusual sound, or is out of adjustment, the student shall turn it off immediately, unplug it so that others don't use it, and inform the instructor directly. If conditions of the shop are such that a hazard is beyond the control of the teacher then it will be reported to the principal.

## 2. Eliminating distractions

- a. The use of cell phones, i-pods, i-pads, or any such devices is prohibited while in the woodshop.
- b. Music will not be played while the shop is in use.
- c. Yellow lines are painted on the floor around machinery. Only one person may be inside the yellow lines at a time. Talking with someone while they are in the yellow lines is not allowed.

## 3. Carrying, moving, storing

- a. When lifting, keep your back straight and lift with your legs. Do not strain yourself.
- b. If something is too heavy, ask for help or use a hand-truck, a lever, dolly, jack, wheels, or rollers. If you must strain to lift or carry something then it is too heavy for you.
- c. Always carry long objects with the front end high enough to avoid hitting someone. If the front end is low, it may not only hit someone, but also strike the ground and put a sudden stop to your movement causing injury to someone following you.
- d. Any left-over wood should be returned to the proper area immediately, do not leave it behind for someone else. Small specialty wood (oak, maple, walnut, etc.) goes in marked bins. Long specialty wood should be returned to their marked shelves. Other "common woods" shall be placed in the upright bins. Plywood is stored in plywood racks.



**Fire prevention**

1. When using power tools it is the responsibility of the student to be aware of a tool getting hot. If this happens immediately turn it off, unplug it, and report it to the teacher.
2. If a tool emits a “burning smell” inform the instructor immediately.
3. Any finishing materials should not be used near an open flame. This would also include thinners and paints.
4. Rags that have absorbed any amount of linseed oil, solvents, stains, paints, or any other finishing products must be disposed in an approved covered metal container as a precaution against spontaneous combustion.
5. Report to the instructor any odor of gas. Gas can not only cause a fire or an explosion, it can also make people ill.
6. When unplugging an electrical cord, always do so by the plug itself and not by the cord. This causes damage to the wires and can eventually be the cause of a fire.

**D. Fire extinguishing**

1. Leave firefighting to the professionals. Call 911 immediately. In the event of a small fire (nothing larger than your hand), put it out quickly before it has time to grow, but know the following:
  - a. Know the location of all fire extinguishers - including hoses - and how to use them.
  - b. Do not hang anything on fire extinguishers. The area around fire extinguishers should be kept clear so that they may be reached without delay.
  - c. Flammable liquid fires should be put out by smothering with non-flammable material. Spraying such fires spreads the fire.
  - d. CO2 extinguishers should be used on gasoline fires and most chemical and electrical fires. Use water, not CO2 extinguishers, on wood or wood product fires.
  - e. Extinguish fires quickly, while they are small. Do not attempt to put out large fires. Nothing we own is worth injuring yourself or losing your life.
  - f. In the event of a fire, do not panic. If it is small (i.e. the size of your hand), put it out immediately. Don't give it time to get large and out of control. If it is a large fire, inform the instructor immediately and calmly follow his/her instructions. Walk calmly to the nearest exit.
  - g. Smoke inhalation and heat can kill you as easily as fire. Stay away.

## Chapter 2

**Hand tools and Power tools****Introduction:**

Hand tools are non-powered instruments used for construction. Unlike power tools, they are not driven by electrical, fuel, or pneumatic (air) power. They are driven by muscle and controlled by the hand. Proper use of these tools will help prevent accidents.

**Hand Tools****A. Hand tool preparation**

1. Make sure tool handles are not split and are tightly fastened. Many injuries occur when the handles of tools come off (hammer head flies off, file tang punctures, saw handle separates).
2. To prevent slipping, make sure your hands are dry and not oily when using tools.
3. Put tools back in their proper place. Do not leave hand tools in the work area or sticking out from workbenches. Otherwise, students may be injured by brushing against the teeth or sharp edges.

**B. Hand tool selection**

1. Use the proper size screwdriver to fit the screw. Improperly sized tools slip out of the screw and may puncture you or your material.
2. Only use a tool for what it is made for. Wrenches are not for hammering, chisels are not for prying, screwdrivers are not for chiseling, files are not for hitting or prying, and so on.

**C. Hand tool use**

1. Most accidents with hand tools will be to the non-dominant hand (the hand not holding the tool), so be aware of hand positioning.
  - a. Screwdrivers: Never hold work in the palm of your hand while using a screwdriver. As a result of doing so you may slip off and inflict a puncture wound. If the work is unstable, secure it in a vise, clamp, or workbench.
  - b. Chisels: Keep your hands clear of the blade. The wood should be secure enough for you to not have to hold it. Use a clamp or vice if necessary. Chisels require two hands to use safely (even if one hand is striking with a mallet).
  - c. Chisels: Chisel strokes should always go away from the body. Place your dominant hand on the handle. With the other hand guide/stabilize the blade. Hold the tool firmly to prevent slipping.
  - d. Hand saws: Start a hand saw cut with the dominant hand on the saw handle and position the saw blade against the thumb onto the mark. Steadily draw the blade backwards. When the teeth bite, push the saw downward (or upstroke depending on the blade) to complete the first cut. Then, release pressure, pull backward, and push downward again for the next cut. Continue this process until the wood is completely cut.
  - e. Hand planers: Work is to be securely fastened in a clamp or vice before planing. Always plane away from you and never put your non-dominant hand on the work being planed.
2. When pounding or cutting, be sure that the chips fly away from you and others.
3. Never throw tools to or at other students.
4. Never hammer on a vise or vise jaws.
5. When handling sharp tools, always point the sharp end down. Do not carry sharp tools in your pocket, do not let sharp tools hang off the workbench, and when handing a sharp tool to someone else always give them the handle first. When cutting with a sharp tool, cut away from your body.
6. When using clamps or vises make sure they are tight before starting work on a project.

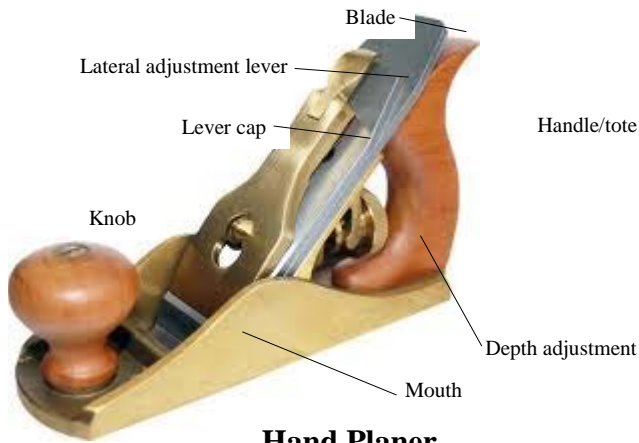

**Hand Planer**

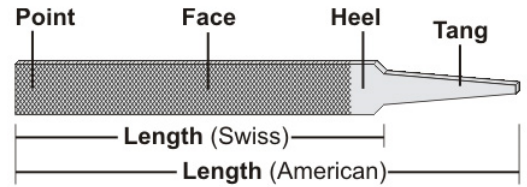

**File** (without a handle)



**Chisel**



**Hammer**

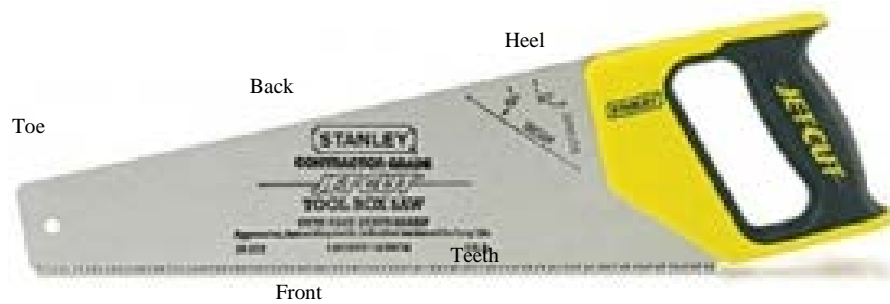

Kerf = width of blade

**Hand Saw**

**Power Tools**

As stated in the last chapter, “whether a tool is safe or not will depend upon you.” If you will learn the general safety guidelines to using power equipment, you will be well on your way to a safe and enjoyable woodworking experience. Here are some keys to remember:

- A. Always wear eye protection
- B. You must be certified on a tool before operating it.
- C. Never operate equipment while the teacher is out of the shop area.
- D. Make sure equipment safety guards are on and working correctly before using any machine.
- E. Avoid wearing loose clothing and tie back long hair while using equipment.
- F. Keep rags away from equipment.
- G. Use a brush to clean chips or shavings off of equipment. Never use your hand.
- H. Never adjust equipment while it is running.
- I. Turn the machine off when you are done and never walk away from it while it is running. Always wait for a blade, bit, cutter, or sander to come to a complete stop before leaving. Never leave it running or unattended. Machines are quieter than you think, and others may not know it is running. Blades are often felt before they are heard.
- J. Do not force wood through the machines as this could result in kick back.
- K. Hold wood firmly when running it through equipment.
- L. Check all wood for knots, splits, nails, etc. to make it safe to cut. Inspect for and remove all nails from lumber before cutting. Try to do layout cuts between knots.
- M. Position yourself properly when using equipment. Maintain a well-balanced solid stance. Know the flow zone and stand away from it. Never walk in the fly zone of another user.
- N. Keep area clear to prevent injury.
- O. Don’t talk to anyone and keep your mind on your work while using equipment.
- P. Always make certain the power switch is in the off position before plugging in a machine. Often times you will have to lean over the machine to plug it in. If it suddenly comes on, you risk being injured. Other times material may be touching the blade and it will be sent flying when you plug it in.
- Q. Always unplug a machine when you are changing a blade or cutter.
- R. Make certain all adjustments and changes to blades, bits, and cutters are tightened properly before turning on a machine. After new cutters are installed, turn on the machine briefly, turn it off, and check the cutter again.
- S. Always allow a tool to reach full operating speed before starting your cut. Feed the wood or cutter carefully and only as fast as the machine can cut easily. Learn to listen for “bog down” (the sound of a slowing blade), and smell for “wood burn” (the smell produced when you are moving too slow or the cutter is dull).
- T. If a tool is not performing properly (or even sounds odd), it may be out of adjustment. Shut it off, unplug it, and tell the teacher immediately.
- U. **BE IN CONTROL, REMAIN IN CONTROL:** Turn on and turn off your own machine. You, as the user, must remain in control and aware at all times.



**The Ten Commandments of Machine Safety**

1. **PAY ATTENTION:** Not paying attention is the number one cause of accidents. Think. Think. Think. Keep your mind on your work. Give your work your undivided attention. Do not look around, talk to others, or use a machine without rehearsing the cut in your mind first.
2. **KEEP MACHINE GUARDS IN PLACE** at all times. Guards are there to protect you. If a guard has been removed tell the teacher so that he/she may put it back on before you begin.
3. **DO NOT OVER REACH:** Never reach across or over a moving blade.
4. **KNOW THE FLY ZONE:** Know where the wood is going to go, kick back, or fly if you lose control of it, and do not stand in that area. For example: A drill press will spin the wood clockwise, so the long side of the material should be to the left. A table saw will throw the wood backward, so stand to the side.
5. **PROPER TOOL USE:** Only use a tool for what it is made for. Understand grain direction, rip-cuts, cross-cuts, blade direction, and proper blade installation. Turn off a tool when you are finished and wait for it to come to a complete stop before leaving. Blades are often felt before they are heard.
6. **PROPER WOOD SIZE:** Many accidents occur simply because a person attempts to cut a piece of wood that is too small or too big. Smaller pieces of lumber are easily grabbed by the blade and the hand holding the wood quickly follows. Because lumber that is too large must be forced into the blade, the extra force required can cause slipping, thrusting, or sudden release. Body parts then lunge forward into the blade. Oversized lumber is under control of the blade, not your hands.
7. **SPECIAL SET-UP APPROVAL:** A special cut requires guards to be removed, and if not done correctly will cause serious injury. Always inform the teacher of any special set-up you are thinking on attempting.
8. **PROPER HAND PLACEMENT:** Always hold the wood firmly. Never cross your arms. Do not push wood hard towards the blade. Do not force wood. You may slip and fall into the blade.
9. **KEEP FINGERS CLEAR:** Keep your fingers clear of blades, rotating parts, pinch points, and electrical plugs by maintaining a clearance of 2 to 4 inches. To assure your safety and the safety of others, only cut wood that is a minimum of 12" long and 3" wide (the 12/3 rule). You must inform the instructor before cutting any piece smaller than the 12/3 rule.
10. **KEEP WORK AGAINST THE FENCE AND ON THE TABLE:** Wood should be firmly against the fence and the table before cutting. The blades and cutters are designed to drive/throw/press the wood against the fence and table. In other words, if you don't have wood there, the blade will put it there for you, along with your hand.

**And two safety tid-bits**

1. **SHARP TOOLS ARE SAFER THAN DULL TOOLS:** Use sharp tools! Dull tools require excess pressure to push, thus increasing the risk of slipping into a blade. Dull tools are also hard to control. Sharp tools do what they're designed to do.
2. **USE YOUR SENSES:** Woodworking requires all of the senses: seeing, smelling, hearing, feeling, and even tasting (believe me you can taste burning wood). Improve your craft: engage your senses. Ensure your safety: engage your senses.

**Work Zones.**  
**Pay Attention**  
**or pay the price.**



## Chapter 3

**Safety Certification****Introduction:**

Though the greatest cause of accidents in the woodshop can be summed up as happening because someone was “not paying attention,” or “didn’t have their mind on their work,” there are many factors that lead to injury. Here are a few<sup>1</sup>:

- |                          |                          |  |
|--------------------------|--------------------------|--|
| 1. Ignorance             | 7. Carelessness          | 13. Lack of judgment                         |
| 2. Rushing a job         | 8. Overconfidence        | 14. Making too heavy a cut                   |
| 3. Talking while working | 9. Using a dull tool     | 15. Using an improperly set or adjusted tool |
| 4. Fatigue               | 10. Using wrong material | 16. Improper body positioning                |
| 5. Absent-mindedness     | 11. Improper clothing    | 17. A disorderly or messy woodshop           |
| 6. Using unsafe material | 12. Eyestrain            | 18. Inadequately guarded machinery           |

So, with your mind on your work, let’s begin...

***Whether tools are harmful or safe depends on you.***

It is important that you fully understand how to properly operate each piece of machinery before using it. That means certification. Before using any equipment in the woodshop, you must be certified by the instructor. Each machine comes with its own set of warnings. Failure to use caution may result in serious injury, even death. Be safe and get certified!

When you fail to practice safety, you put yourself and others in danger. Remember, the greatest virtue you have is patience, and your most valued skill is the ability to stay focused. Don’t get hurt, and don’t hurt others by:

- Talking while working
- Causing loud, sudden noises unrelated to the woodshop (yelling, sneezing obnoxiously, slamming, etc.)
- Cutting while someone is in your fly zone
- Leaving behind a mess
- Leaving unused wood laying around
- Leaving tools out
- Not replacing dull or overused equipment
- Leaving stuff on the floor that can trip people up (cords, boards, tools, etc.)
- Not clamping work appropriately
- Swinging tools wildly
- Using tools in an unsafe manner
- Getting too comfortable with a machine
- Being a know-it-all about a machine
- Holding wood for a person while they are cutting it on a machine
- Crowding someone on a machine
- Hurrying someone while they are on a machine
- Distracting people by drawing unnecessary attention to yourself
- Using a tool you have not be certified to use
- Ignoring, forgetting, or otherwise not thinking about the safety requirements of the machinery
- Taking advice from someone other than the instructor

In order to be safe, you must know the dangers that come with each piece of equipment. You should know exactly what a machine is used for and what it is not used for. You should know the warnings that come with the tool. And, you should know the major cause of accidents that occur while using the machine. The following pages are an overview of the commonly used tools in the VOCS woodshop and the tips to keep in mind while using them. You will need to know this information in order to be certified.

<sup>1</sup> Woodworking Manufacturing Technologies Department, Cerritos College; *Woodworking Safety Manual and Test* (Norwalk, CA, 2008). p. 2

## Miter Saw

**Purpose:** A miter saw, also known as a *chop saw*, is used to make an accurate [crosscut](#) in a workpiece.

**Warning:** Most accidents occur with this tool.

**Major cause of accidents:** Not paying attention, cutting too small of a piece, rip cutting, and working too fast.



### **Operating and safety instructions:**

- Always wear eye protection. Ear protection, though not mandatory, is recommended.
- Be sure blade is sharp, runs freely and is free of vibration.
- Allow the motor to come up to full speed before starting cut. Make sure blade is not contacting work piece before switch is turned on. Engage power switch with miter saw in fully raised position. The motor has a high torque and it will jump in your hand. Never lock the switch in the ON position.
- Keep motor air slots clean and free of chips.
- Always make sure rotating table is tight before cutting, even if the table is positioned in one of the positive stops.
- Be sure blade and flanges are clean and that the arbor screw is tightened security.
- Always keep the blade guard in place and operating properly.
- After completing a cut, keep the handle down, then release the power switch and wait for coasting blade to stop before returning saw to raised position.
- Do not remove jammed or cut off pieces until blade has stopped.
- Never cut ferrous metals or masonry with wood cutting blades.
- Always clamp your work. Never re-cut small pieces. Follow the 12/3 rule (12" long and 3" wide). If it can't be clamped, it is too small.
- Danger zone: Never have your hand on the miter saw rotating table. Know and follow this boundary.
- Make certain the workpiece is firmly pressed against the fence and the table at the same time. If it is not, the blade will grab it and drive it until it hits something, often times taking your hand with it.
- Provide adequate support to the sides of the saw table for long work pieces.
- Clean it before leaving it. Never leave a machine or the area around it dirty or cluttered with scraps.
- All adjustments shall be made to the miter saw prior to starting
- Never cross your hands when operating the miter saw.

## Drill Press

**Purpose:** Drilling holes into the workpiece.

**Warning:** Workpiece must be safely secured before drilling.

**Major cause of accidents:** Loss of control of workpiece, failure to remove chuck key

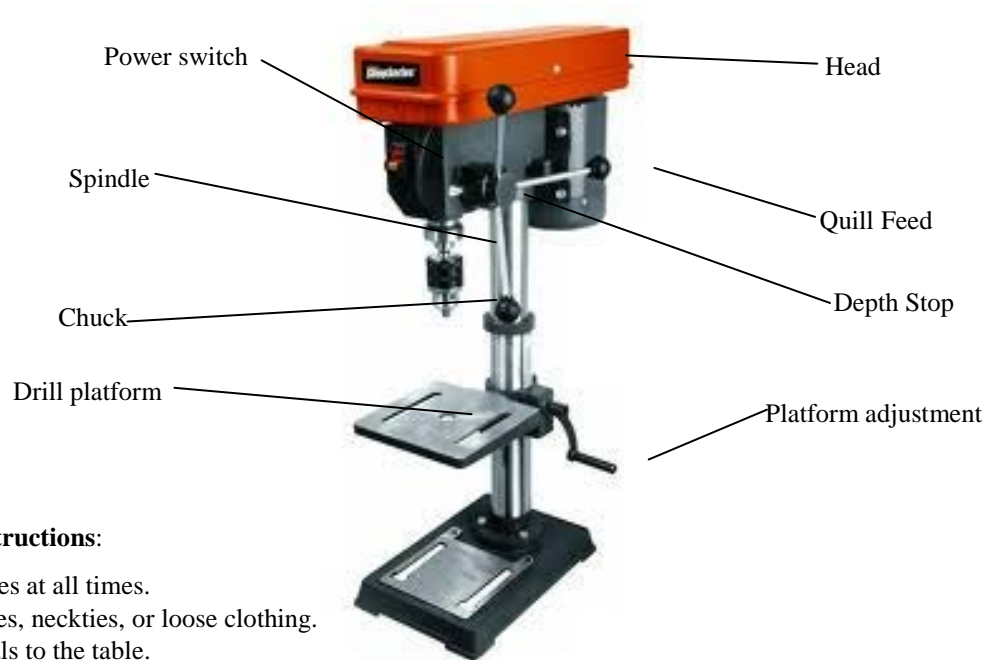

### **Operating and safety instructions:**

- Wear safety glasses at all times.
- Do not wear gloves, neckties, or loose clothing.
- Clamp all materials to the table.
- Do not drill material too small to be securely clamped to the table.
- Make sure the depth stop is set correctly before drilling. If not set correctly,
  - you may not drill the correct depth in or through your stock
  - you might drill into the drill press table which could damage the bit and the table.
- Always place a piece of scrap wood under the work piece so you don't drill into the table and to avoid wood splintering on the exit hole.
- Use the correct bit for the job being performed.
- Make sure the chuck key is removed from the chuck and put away before starting the drill press. Otherwise it will fly out and may hit you when the machine is turned on.
- Round or irregular stock should be placed in a v-block before drilling. This will keep the wood from rolling or moving.
- Always keep hands out of the path of a drill bit.
- Never turn on your drill press before clearing the table of all objects (tools, scraps of wood, etc.).
- Let the spindle reach full speed before starting to drill. If the drill press makes an unfamiliar noise or if it vibrates excessively, stop immediately, turn it off, unplug it, and inform your teacher immediately.
- Make sure the spindle has come to a complete stop before touching the work piece.
- For safety and control, your hands and fingers should be as far away from the drill bit as is practical, with a minimum of 3".
- When drilling a long piece of stock, place the excess stock to the left of you. By doing so, if you lose control the long end will rotate and hit the drill press stand and not you.
- When drilling a deep hole, raise the bit often so that chips can escape the hole and give the bit a chance to cool.
- When drilling begins to break through the underneath side of the stock, you should ease up on the feed pressure slightly. Do not punch the bit through the other side. If the workpiece is going to get caught and spin out of control it will most likely happen on your exit.
- Never wear gloves when drilling wood.

### Disc/Belt Combination Sander

**Purpose:** Also known as the *combo sander* or *table sander*, this machine is used for the fine sanding or removal of material on both the face and edge surfaces of a workpiece.

**Warning:** Both the disc and the belt move at the same time.

**Major cause of accidents:** Not paying attention, slipping into the sander, losing control of workpiece, removal of stop.



#### **Operating and safety instructions:**

- Always wear eye protection.
- Make sure the sanding belt is tracking correctly in order for it not to run off the pulleys.
- Make sure the sanding belt or disc is not torn or loose, such pieces cause malfunctions and loss of workpiece control, not to mention the damage it can cause to your wood.
- When sanding with the belt sander, hold the workpiece firmly on the top edges and support it against the backstop. Never let it go. It will fly.
- When sanding on the disc, always hold the workpiece firmly on the table. Never let it go. It will fly off.
- When sanding on the disc, always sand on the downward stroke of the disc. Sanding on the upward side can cause the workpiece to lift up off the table and cause an injury.
- Make certain the table and backstop are properly set. Always maintain a minimum clearance of 1/16" or less between the table or backstop and the sanding belt or disc.
- Turn on the machine briefly to make certain it is tracking correctly. Make certain the table and backstop are properly set.
- Never wear gloves or hold the work with a rag when sanding. Such items can result in loss of control.
- Sand with the grain of the wood: Face and edge grain with the belt. End grain sanded on the disc. Not following this rule will cause damage to your wood, scratch marks sometimes not seen until you stain.
- Do not sand pieces of material that are too small to be safely supported and controlled.
- Avoid awkward hand positions where a sudden slip could cause a hand to move into the sanding belt or disc. Never cross your hands.
- When sanding a large workpiece provide additional support at table height or use a hand sander instead.
- Whenever possible, attach a vacuum to the sander and run it while sanding is in process. When sanding for long periods of time, you should wear a dust mask or air respirator
- Always remove scrap pieces and other objects from the sander before turning the machine ON
- Never layout, assemble, or set up work on the table while the sander is operating (moving).
- Always turn the machine OFF and disconnect the cord from the power source before installing or removing accessories.
- Never leave a machine with the power left ON or before the machine has come to a complete stop.
- When sanding on the belt sander, you should start the sander first, then make careful contact with the workpiece to the moving belt or disc.

## Scroll Saw

**Purpose:** A scroll saw is for cutting intricate curves.

**Warning:** Your fingers a close to this blade.

**Major cause of accidents:** Not paying attention, safety guard is removed, fingers slip into the blade.

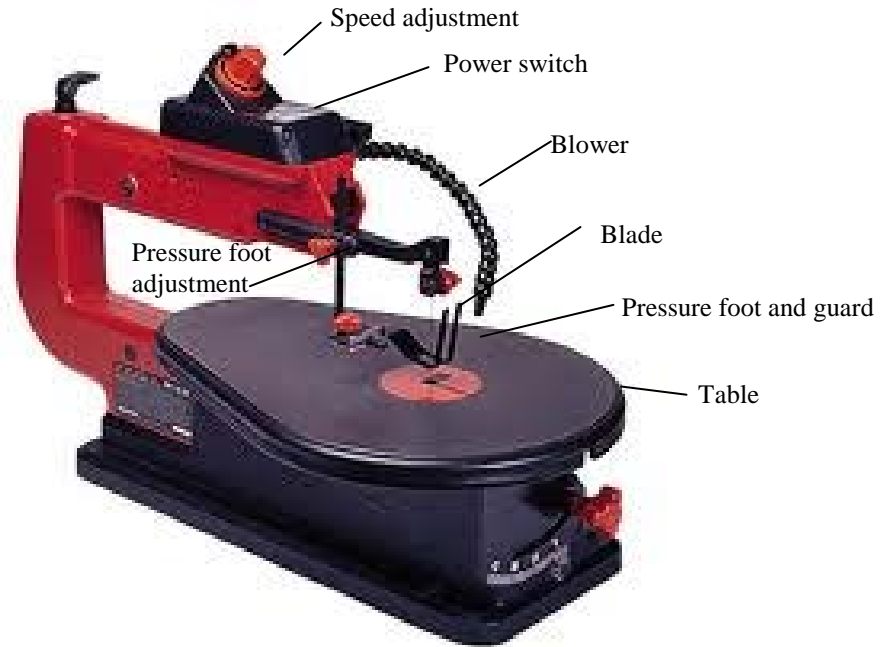

### **Operating and safety instructions:**

- Always wear eye protection.
- Before turning on power:
  - make sure the instructor has checked your set up.
  - make sure everyone is a safe distance away before you start, outside yellow lines.
  - be sure teeth are pointing down and that the blade is sharp. Blades that are dull or that have missing teeth can require excessive force in feeding which may damage the blade.
- Firmly support stock against downward thrust of the saw. Do not lift wood from the table while cutting.
- If the blade breaks during operation, immediately shut off power, stand clear of the saw and notify instructor.
- Clean it before leaving it. Never leave a machine or the area around it dirty or cluttered with scraps.
- To make an internal cut, first drill an appropriate size hole to insert the blade into, set the blade, and then begin cutting.
- Maintain a 2" margin of safety. When possible, push by moving only your fingers, not your hands.
- Do not remove the safety guard/pressure foot.
- Do not clear scraps from the table until the saw comes to a complete stop.
- The pressure foot is designed to hold the workpiece securely down on the table. If you hear knocking as a result of your wood slapping up and down, your pressure foot is not set correctly.
- All adjustments to the scroll saw shall be made prior to starting.
- When cutting with the scroll saw, your hands should hold the workpiece firmly.
- If a small piece of wood gets caught in the throat against the saw blade, you should turn off the machine and clear it.
- When backing out of a long cut, you should turn off the machine to avoid breaking the blade
- To help keep a blade from binding when cutting an arc, use a series of cuts vertical to the arc, called "relief cuts."

## Chapter 4

**Virtues of Woodworking****Introduction:**

Virtues are a quality of your personality and character that benefits yourself and others. A virtuous person is said to be someone whose behavior is highly respected. For your safety and the safety of others, we in the Valley Oaks woodworking department expect students to be virtuous woodworkers. Below is a list of virtues we expect students to practice in their lives.

**Patience:** Patient people do not rush or hurry needlessly and carelessly. This virtue is perhaps the most beneficial for the safety of the woodworker. When you are impatient, mistakes happen, sometimes painful ones. Don't let this happen to you. Be patient!

**Diligence:** Diligence is the ability to stay focused, work hard, and be attentive. When you come to the VOCS woodshop, you come to work. Be self-motivated and take initiative, don't just stand around. If you don't know how to do something, ask.

**Creativity:** Being creative means you use the resources provided to come up with your own ideas, plans, and special touch. Look for ways to add that little extra to your work. Creativity is always accepted. In fact, in woodworking we like to think that we never make mistakes; we just create opportunities to be creative.

**Cooperation:** Working well with others is a valuable asset. Don't rush others. Be kind, gentle, and considerate of the time, beliefs, and abilities of others.

**Sobriety:** Being sober simply means that you think clearly. Come to class with a clear head. Use common sense when working in the shop. Take time to clear your head and consider what you are doing.

**Critical thinking:** While in the woodshop, you will be expected to think for yourself. The woodshop is designed to build self-confidence. If you rely on others for answers, you'll never develop the confidence necessary in life. Be creative and think through solutions before asking others.

**Honesty:** It is expected that students be honest in everything they do. They do not copy other people's work, cheat on tests, or turn in projects they did not do. Do not let others do cuts for you. If you are scared, be honest and inform the instructor so that appropriate steps can be taken to help you. Moreover, if you break something, tell the teacher. The bottom line is to take responsibility for yourself and own up to your mistakes.

**Respect:** Students are to respect the instructor, each other, and the property of VOCS. Treat people better than you want to be treated, and treat property better than you treat your own property. The woodshop is a privilege not a right, so be respectful in all you do.

## Woodworking Terminology

### Introduction:

Believe it or not, a part of safety is terminology. It is important that you understand the terms being used in the woodshop so that you don't get confused and do something wrong. As is always the case, "Ask if you are ever unsure about what has been said." Study the words and phrases below for your safety and the safety of others. Confusion only gets people hurt.

### Woodworking Terminology

1. Board Face: The widest part of the board where wood grain lines run end to end.
2. Board Edge: The side of the board where wood grain lines run end-to-end.
3. Board End: The end of the board where the grain fibers end.
4. Fence: The part of woodworking machinery perpendicular from the table surface.
5. Grain: Formed from the growth rings of a tree as a result of the fibers in wood that carry water from the roots through the trunk. The part of lumber lines/patterns that alternate between darker and lighter colors.
6. Grit: Abrasive material, such as sand, used for removing wood. When sand is glued to paper it is called "sandpaper." Grit refers to the degree of roughness. Grit may be coarse (very rough) to fine (smooth), and is defined by the size and amount of sand granules in a square inch.
7. Kerf: The width of the cut left behind from a blade, typically 1/8". The amount of wood the blade removes when cutting.
8. Warp: The distortion of lumber from its original shape. Generally speaking, it is a twisting or bending in the lumber away from straight.
9. Clamp: A device used to hold lumber tightly to a work surface or to other boards for gluing.
- 10.

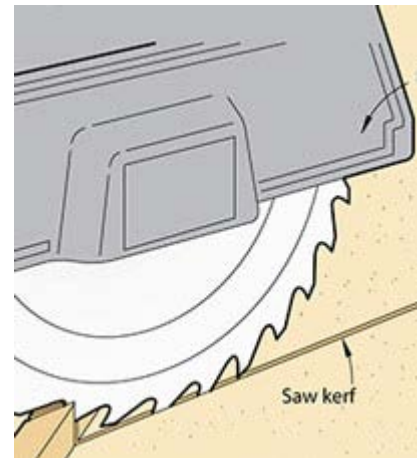
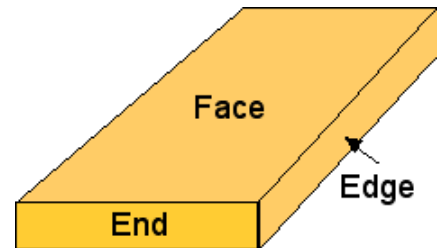

13. Countersink: The process of drilling a larger hole over the top of a smaller hole, called a pilot hole, so that the head of a screw recesses into the wood when it is screwed in.
14. Kick-back: When a piece of lumber is forced or thrown backwards by the blade in the direction of the machine operator.
15. With the grain/across the grain: With the grain means parallel to the grain lines. Across the grain means perpendicular to the grain lines.
16. Rip Cut: Cutting with the grain of a piece of lumber, parallel to the grain lines.
17. Cross Cut: Cutting across the grain of a piece of lumber, perpendicular to the grain lines.

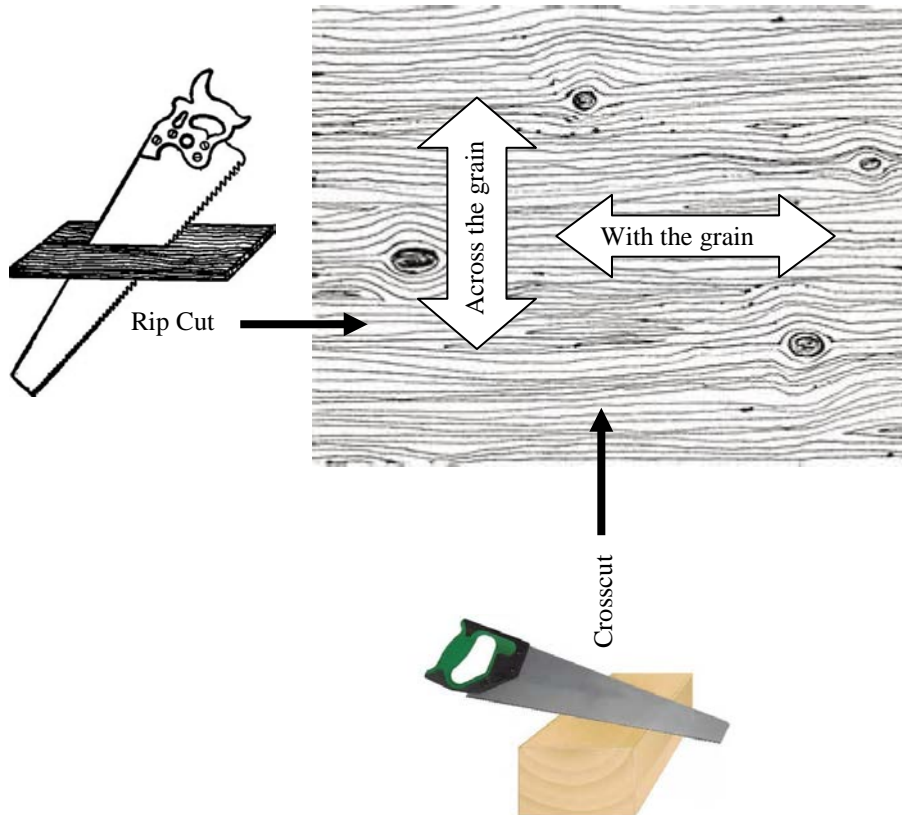
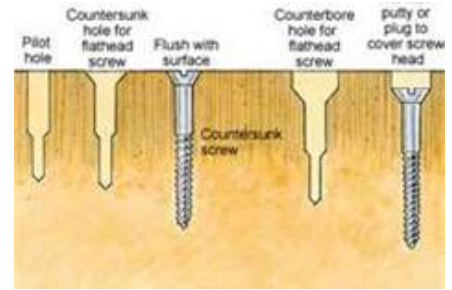



# drafting

## Unit 2



**Introduction to Drafting**

**Multi-View Drawing**

**Line Type and Quality**

**Dimensions and Notes**

**Sections**

## Unit Prompts

Answers to prompts must include one reference from the class text and one reference from an internet article (dictionary and encyclopedia resources will not be accepted). Be sure to put quotation marks around your citations, number them, and place footnotes at the bottom of your paper to reference where your citation came from.

*Prompt 6: In 150 words, explain why it is important to draw out your project before building it. Include an explanation of the terms “think it through” and “plan the work, work the plan.”*

*Prompt 7: In 150 words, explain the different views necessary for drafting working drawings and the information that is needed on each.*

*Prompt 8: In 150 words, explain the terms: Hidden line, dimension line, object line, and section line. Draw a sample of each and label when are each used.*

*Prompt 9: In 150 words, describe the different tools: straight edge, 30/60 triangle, 45 triangle, circle template, and compass. Draw an line and/or circle with each tool and dimension the image using proper dimension lines. Make certain you pay attention to line quality, line type, and arrow heads.*

*Prompt 10: In 150 words, explain the meaning and purpose of section drawings. You may illustrate your answer.*

## Chapter 6

**Introduction to Drafting****Introduction:**

**Drafting** is the process of creating a technical drawing to communicate how something is to be constructed. Therefore, it is essential to draft a plan before you begin any woodworking project. The failure to do so results in lost time, lost material, lost money, and lost focus. Without a drafted plan your attention is divided between cutting and assembling. In other words, while cutting wood without a plan you are also thinking about how the project will go together, what the next cut needs to look like, and what needs to happen next. Since the number one reason for accidents in the woodshop occurs when people do not have their mind on their work, it is reasonable to say that drafting a plan not only makes sense to know what to do, but it is also safe. Therefore, plan the work, work the plan. Think it through before you ever begin cutting. Draft a plan!

**Plan the work...**

To plan the work you need to first know what the finished product will look like. This can be accomplished by looking at an already completed project, a picture of the project, or a sketch. Having the finished product in mind will help you understand the drafted plans.

Next, you will need to know how the pieces go together to make the project. This is done by drafting a scaled technical drawing, or a plan. Drawing to *scale* means that the images on the drawing sheet are drawn in proportion to the finished product. That is to say, the drawing is an exact representation of the actual product, only smaller or bigger. With this drawing the woodworker can see clearly the exact sizes and shapes to be cut and assembled.

A scaled drawing can easily be accomplished by using graph paper. For more sophisticated projects the use of an architect's scale is necessary. **Graph paper** is a sheet of paper with a series of squares aligned in columns and rows filling the sheet. The most common size square is  $\frac{1}{4}$ ".

When using graph paper, simply predetermine the "value" of each square. This value is called the *scale*. That is to say, decide what each square will equal to draw your project proportionally ( $\frac{1}{4}$ " = 1",  $\frac{1}{4}$ " = 2",  $\frac{1}{4}$ " =  $\frac{1}{2}$ ", and so on). For example, if your drawing scale is  $\frac{1}{4}$ "=1", for every inch of actual size of your project, you will draw it  $\frac{1}{4}$ ", or one square. Let's say that the side of your picture frame is 9". On your drawing, you would draw a line 9 squares long, or 2  $\frac{1}{4}$ ". You will learn more about scaling a drawing in Unit III: Measuring. For now, you just need to know the basics.

Once you have decided your scale and are certain that your drawing will fit on the sheet of graph paper with the scale that you chose, it's time to start drawing. Your drawing should include all of the necessary information required for building your project. This means you will have to "think it through."

**Think it through...**

Thinking it through means that you consider how each joint will be fastened, the size of lumber you will need, and the size of each cut. You should know all of this **BEFORE** you begin cutting. As you draft your project, build it in your mind. Then, communicate it clearly on your drawing. Your drawing should have the answer to every question a builder may ask about the project.

**Work the Plan...**

Once you are finished drafting your project, you will know everything there is to know about how to build it: the size of your cuts, the diameter of your holes, the radius of an arch, the method of joining wood together, and the size of lumber to pull from the rack. Now, work the plan. Simply follow what you have drawn. Cut all of the pieces first. Then, assemble them.

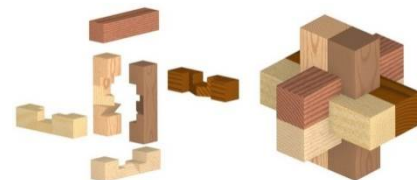

**Drafting Tools:**

Before we begin drafting, let's first look at the tools you will need.

1. Graph paper: A sheet of paper with a series of squares aligned in columns and rows filling the sheet useful for drawing images to scale.
2. Pencil: Do not draw in ink. Always use a pencil, and begin with a light sketch. You will darken the lines later.

3. Straight edge: A straight edge is precisely that...a straight edge. It is a hard, smooth tool used for guiding your pencil to assure that your lines are straight. Always use a straight edge. Do not freehand sketch a finished drafted plan. The most common straight edge used for drawing horizontal lines is a T-square, which is also used to hold drafting triangles (see below).

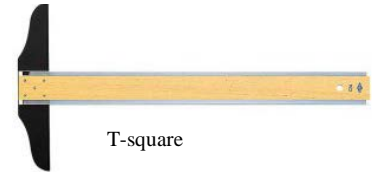

T-square

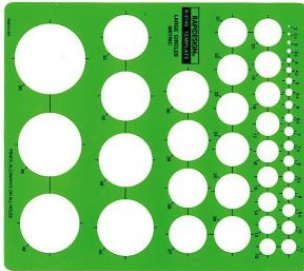

4. Circle template: A circle template is a smooth, hard flat tool used for drawing circles or arcs.

5. Drafting compass: A drafting tool used for drawing circles or arcs.



6. Triangles: Triangles are flat surfaces shaped like triangles used for drawing straight lines

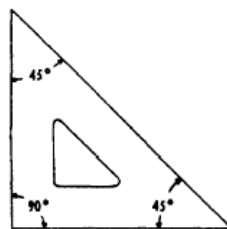

45° TRIANGLE

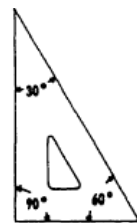

30°/60° TRIANGLE



Chapter 7

**Multi-View Drawings**

**Introduction:**

In order to effectively plan a woodworking project and think through each step of assembly before you begin, it is necessary to study it from a number of different angles, or views. This study is called a *multi view technical drawing*. Simply put, a *view* is how something is seen, and in drafting there are many different types of views to help you see exactly how something is built. The standard views required in any drafting project are the front, top, and right side views. On more complex projects more views are required, but for the most part, these three views will communicate everything you need to know as to how to construct a simple project.

To illustrate how this is done, we will consider the elements necessary for drawing a two dimensional (flat) drawing of a small wooden cd rack (right), the dimensions of which we already have acquired.



**Before you Begin:**

As we discussed in the last chapter, begin by choosing the scale of your drawing. Because we want to fit all three views on the same piece of paper, we will use a 1/4" = 1" scale. After determining the scale, draw a title block around your paper. The title block is a thick line boundary, like margins of an essay, this boundary will frame your drawing and provide space to include important information about the project (see sample on the next page).

**Where to Begin:**

Since the cd rack is a small project and all three views will fit on the same page, begin drawing the first image, the front view, near the bottom left-hand corner of your paper. When drawing multi view images, the views fold out from one another. We place the front view in the bottom corner because all other views will *fold out* from it. That is to say, the top view will be directly above the front view, and the right side view will be directly to the right.

Lightly sketch your drawing on the piece of graph paper first. This will make it easy to make changes before you draw your finished product. We will worry about line quality and thickness in the next chapter.

**Front View:**

The front view is the image of the object looking straight at it. Every line represents a line as seen in the actual product. Wood has a thickness, so do not draw a single line to represent a piece of lumber.

The sides of this cd rack are 13" tall. On a 1/4" scale, that means the line you will draw to represent one edge of the lumber is 3 1/4" long, or on 1/4" graph paper, 13 squares long. Now, you must draw the other edge of the lumber. The wood you will use is 3/4" thick. Measure over from your first line a little less than one square on your graph paper, or 3/16", and draw your next line parallel to the first. These lines represent each edge of the board.

Connect the top and the bottom with horizontal lines and, congratulations, you've drawn one front view side of your cd rack. Now, repeat the process for each piece of the cd rack and when completed, it will look something like the illustration on the right.

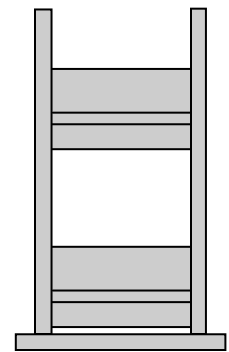

**FRONT VIEW**

**Top View:**

The top view is the image of the object looking down on it. This view is drawn directly above the front view. In fact, every corner of the front view drawing should line up exactly with the top view.

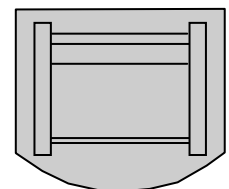

**TOP VIEW**

**Right Side View:**

The right side view is drawn directly to the right of the front view. It is what is seen if you stepped to the right and looked at your image. Every corner on the front view should line up exactly with the same corners on your right side view.

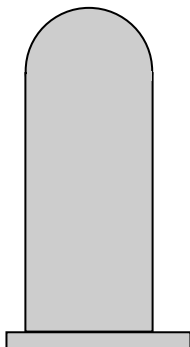

**RIGHT SIDE VIEW**

Below is a finished example of a multi view drawing. The photographed image of the cd rack is added for clarity. Next, we will focus on line quality, dimensions, notes, and other important views.

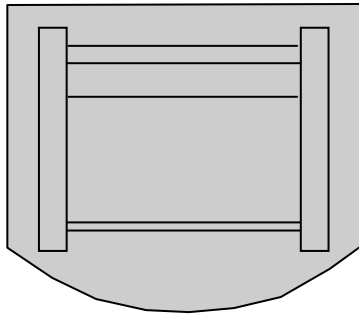

**TOP VIEW**

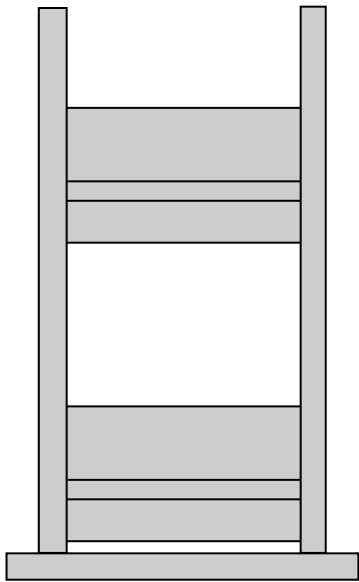

**FRONT VIEW**

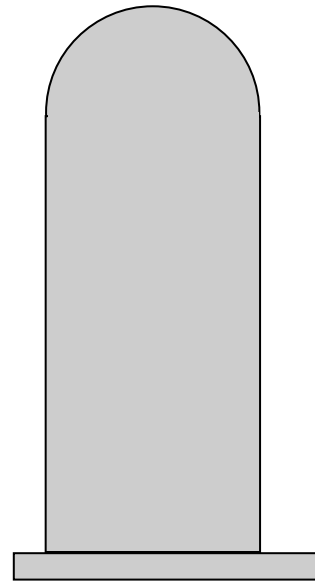

**RIGHT SIDE VIEW**

Name:	<h1>CD Holder</h1> <p>Scale 1/4" = 1"</p>	
Date:		
Class:		

Chapter 8

**Line Types and Quality**

**Introduction:**

With technical drawings, much attention is given to line types and quality. These two important features provide for an easy-to-read and easy-to-follow drafting standard.

**Line types:**

The type of line used in a technical drawing is important. Below is a description and example of each line type:

**Object Lines**

Heavy, Dark Solid Line 

When a person looks at a drawing the first thing they should see is the object, or the item to be built. This is accomplished by using heavy dark solid lines. All other lines will be thinner and lighter than the object line.

**Dimension and Extension Lines**

Thin, Light Solid Line 

Dimension lines inform the viewer the size of objects. Because the object should stand out more than any other line, dimension lines should not be close to the object lines. They should be at least one inch away. A dimension line has two elements, the extension line and the dimension line. The extension line is drawn perpendicular from the object for which the measurement will be noted. The dimension line is drawn parallel to the object reaching to each extension line with an arrow head. On the dimension line, the measurement is noted, looking something like this:

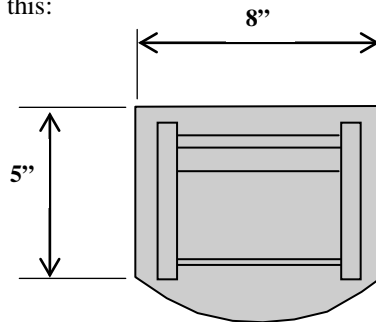

**Center Lines**

Thin, Light Broken Line 

Center lines are drawn to show the center point of a circle or an arch. It is drawn the same thickness and weight of a dimension line, only with small breaks towards the end of the line. When showing the location of a circle or an arch, the center line will always extend to the center point of the circle, symbolized with a small cross. This tells the manufacturer the exact location to place the center of the drill bit.

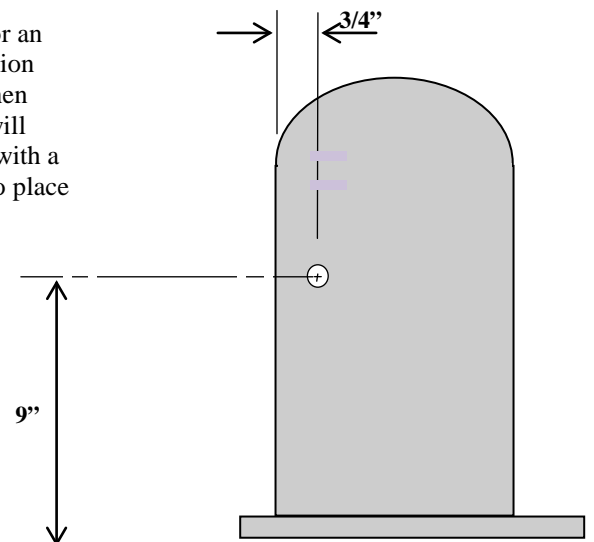

**Hidden Lines**

Thin, Medium Dashed Line

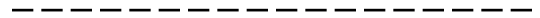

There are times when an object is hidden from view. Meaning, it is behind or inside the object being drawn. This object still must be shown. To do so, hidden lines are incorporated. They are drawn just like an object line, only not as thick and with dashes. In the case of the CD rack on the right, the parts constructed to hold the CDs cannot be seen from the side view, so we use hidden lines to show they are there. Never use dimension lines on hidden objects.

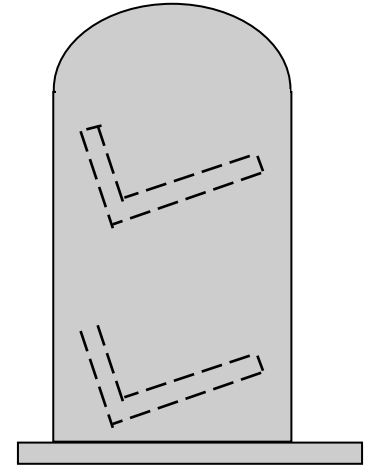

**Section Lines**

Heavy, Dark Broken Line

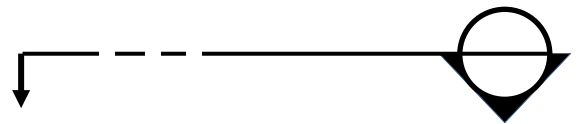

Sometimes it is necessary to show the inside of an object. In this case we use what is called a section line. Section lines are heavy, dark broken lines with an arrow on one end and a section symbol on the other. Think of it as a visual cut line. In essence, the section line tells the manufacturer where you as the draftsman will cut open the object and show the inside to provide necessary information. Section lines may be placed on the front view, top view, or side view. In the case of our CD holder, the racks cannot be seen from the side view, so we place a section line on the top view to indicate we've drawn an inside view (a section) of the object.

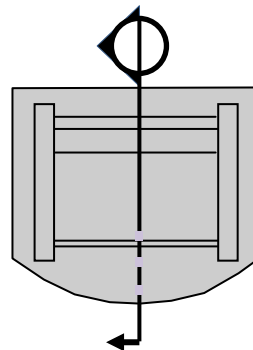

**Line Quality:**

Drafting plans are drawn instructions of how something is manufactured. As such, they must be easily understood. Like any instructional material, if you can't read it, it's no good. **Line quality** is one method used to insure the readability of your plans. Remember, drafting is an art form, but it is a technical art form. That being said, no sloppy lines are allowed. Line quality has to do with clean, crisp, and sharp lines. Corners do not over extend, arcs have a tangent, and circles have a center. The lines are uniform, dimensions do not crowd the object, and dimension lines are always parallel to the object measured. Keep your pencil sharp, keep your lines straight, and use the correct line type.



Below is a finished example of a multi view drawing. The photograph image of the cd rack is added for clarity. In future chapters we will focus on line quality, dimensions, notes, and other important views.

**NOTES:**  
 1. ALL JOINTS TO BE SCREW FASTNERS WITH 1/4 COUNTERSINK  
 2. CAP ALL HOLES

**TOP VIEW**

**FRONT**

**RIGHT SIDE**

**CD Holder**  
 Scale 1/4" = 1"

Name: \_\_\_\_\_  
 Date: \_\_\_\_\_  
 Class: \_\_\_\_\_

Chapter 10  
**Sections**

**Introduction:**

Sometimes when drawing a technical drawing, to properly instruct the manufacturer as to how the item is to be built it is necessary to show the inside of the project. This is done by drawing a section. A section drawing is the view of an object showing what it would look like if it were cut open along what is called the cut line. Imagine cutting along an imaginary cut line and looking into the object. A cut line may be shown on any view: top, front, or left side view. This cut line will inform the manufacturer where the cut for the section view is made, what angle the view will show, and the letter indicating where the drawing may be found.



For example, to properly construct the cd holder, the builder needs to know the size of the shelves and how they will be attached. Because that information cannot be seen from any of the three views we provided, we will need to show the inside of the holder. That is best accomplished by cutting the cd holder open vertically. As you can see, on the front view we have drawn a section line, or cut line, indicating the direction of the view the section will show. The result is shown below.

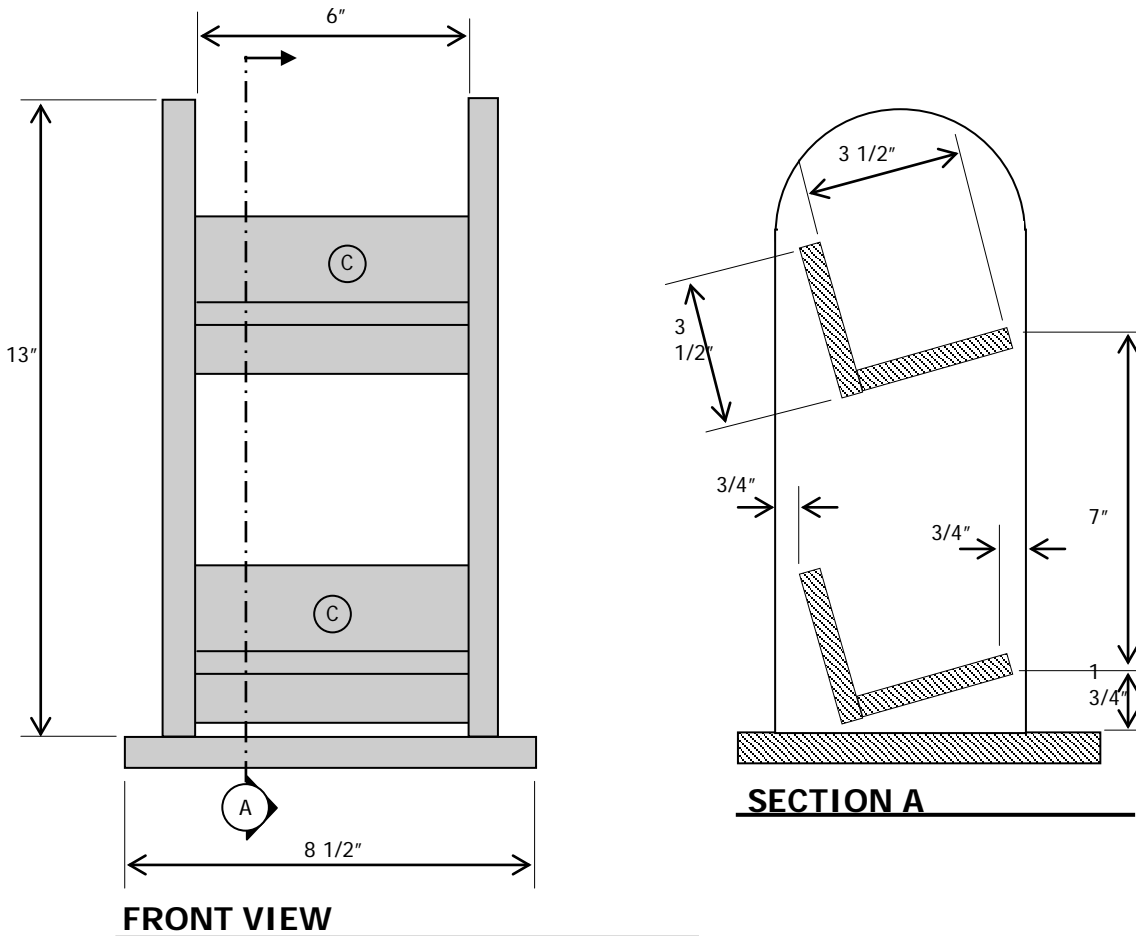

The final result of our working drawing is shown here:

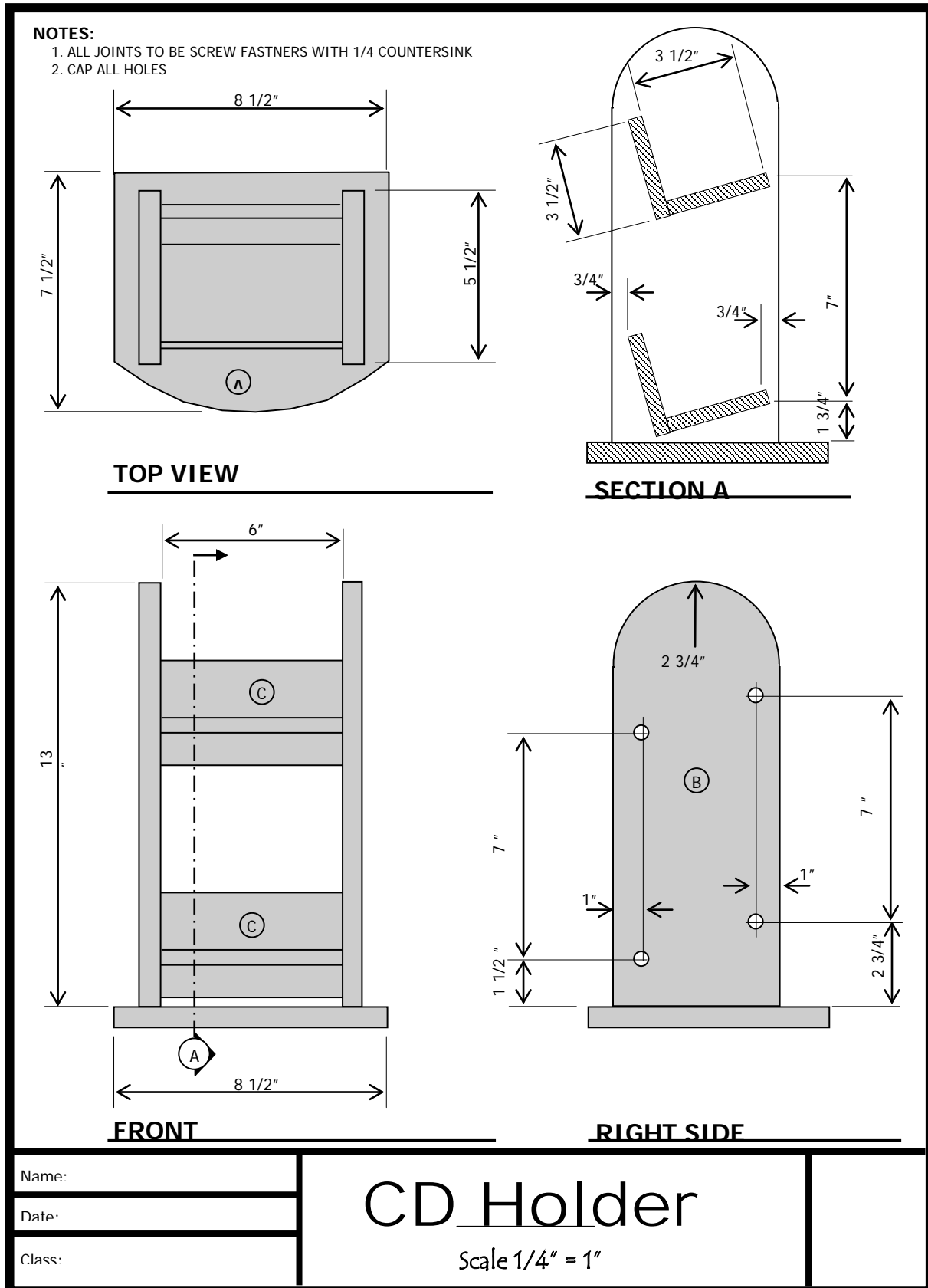



## Unit 3



**How to Measure**  
**Measuring Terminology**  
**True Size**

## Unit Prompts

Answers to prompts must include one reference from the class text and one reference from an internet article (dictionary and encyclopedia resources will not be accepted). Be sure to put quotation marks around your citations, number them, and place footnotes at the bottom of your paper to reference where your citation came from.

*Prompt 11: Write out your own instructions teaching someone how to measure something using a tape measure to the nearest  $1/8$ ". Then, draw a line for each of the following lengths and label them:  $4\ 1/2$ ",  $5\ 1/4$ ",  $2\ 3/4$ ",  $1\ 1/4$ ",  $3/4$ ",  $6\ 1/2$ ",  $3\ 5/8$ ",  $7/8$ ",  $7\ 1/8$ ".*

*Prompt 12: Define the term height, width, and depth. Then, illustrate what parts of a piece of lumber are the height, width, and depth. Next, illustrate what parts of a cabinet are the height, width, and depth. Finally, draw a line for each the following lengths:  $2\ 3/8$ ",  $6\ 1/4$ ",  $7\ 3/4$ ",  $2\ 5/8$ ",  $4\ 7/8$ ",  $1\ 1/2$ ".*

*Prompt 13: What does the "true size" of lumber mean and why is it different than the named size? Make a chart listing the true sizes of a  $1 \times 2$ ,  $1 \times 3$ ,  $1 \times 4$ ,  $1 \times 6$ ,  $1 \times 8$ ,  $1 \times 10$ ,  $2 \times 2$ ,  $2 \times 4$ ,  $2 \times 6$ ,  $2 \times 8$ , and a  $2 \times 10$ . Finally, draw a line for each of the following lengths:  $7\ 13/16$ ",  $8\ 3/4$ ", and  $5\ 5/8$ ".*

## Chapter 11

**How to Measure****Introduction:**

For many people, measuring is not an easy concept to grasp. With so many lines on the tape measure or ruler it can be very confusing. Yet, in woodworking, measuring is a must. Of course, the best way to learn is to practice, practice, practice. As you do, your eye will become trained to recognize how the inch is divided. Below are some key concepts to help you get started.

**History of Measurements:**

Uniform measurements, as you can imagine, are very important for maintaining peace and fairness in a society. Without a standard of measure, people could easily cheat others, arguments could erupt as people disputed the “size” of something promised, and manufacturing, selling, and purchasing would be nearly impossible. To solve this problem, kings developed units of measurement. In America, we primarily use the United States Customary system, which makes use of the inch, foot, yard, and mile.

The size of the inch was declared by the king to be the average width of a man’s thumb, the foot was the length of his foot, and the yard was the distance from his nose to his fingertips. Basically, a man could fit 12 thumb widths into his foot size, and three of his feet could fit into the reach of his arm. So, eventually the standard rule or law (later called the “ruler”), created a measuring stick where 12 inches formed a foot, and three feet created a yard. With this standard of measurement recorded on the ruler, everyone has the same unit of measure. The ruler ruled over all decisions, because the Ruler King ruled it so.

**Fractions:**

When we measure something, however, not every measurement falls exactly on an inch, a foot, or a yard. When a measurement doesn’t reach to an exact inch, but only reaches part of the way between the inches, we call this measurement a fraction.

“Half” of something is the exact middle between two points. So, anytime a measurement was divided into two equal parts, the term *half* was used for each of them. As seen illustrated in the pie on the right, one half (written  $\frac{1}{2}$ ) of the pie has been removed.



Dividing a pie is like dividing an inch. Each inch can be divided into small equal parts call fractions. If the inch is divided into two equal parts, we call the distance one half of an inch ( $\frac{1}{2}$ ). If the inch is divided into four equal parts, we call each part a fourth ( $\frac{1}{4}$ ). If the inch is divided into eight equal parts, we call it one-eighth ( $\frac{1}{8}$ ). Moreover, if the inch is divided into sixteen equal parts we call each part one sixteenth ( $\frac{1}{16}$ ). Notice that the number on the bottom of the fraction simply tells you how many equal parts something is divided into.

**Reading the Ruler:**

This is why a ruler has so many lines. The lines are like slices of pie dividing the inch into equal parts. To make it easier to read your ruler while measuring, each of these lines are different in length.

Take a look at the measuring rule below. Let’s focus on the dividing lines between the 10” and 11” mark. Can you see the different length of lines? If you count the spaces between each small purple line, you will see that there are sixteen spaces. That means that each of those lines is  $\frac{1}{16}$  of an inch apart. You will also notice that those lines are the shortest. Now, look at every second space, or the next longest yellow line. If you count the equal spaces between them, you will find that the inch has been divided into eight equal parts. We call these  $\frac{1}{8}$  of an inch. The change in length and color of the lines is because two of the shortest lines ( $\frac{2}{16}$  of an inch), is equal to  $\frac{1}{8}$  of an inch ( $\frac{2}{16}$  reduces to  $\frac{1}{8}$ ). Next, look for the next longest line dividing up the inch, the green line. It is found to divide the inch into four equal parts. We call each of these  $\frac{1}{4}$ ”. The remaining, and longest blue line between the inch marks is  $\frac{1}{2}$ , because it divides the inch into two equal parts.

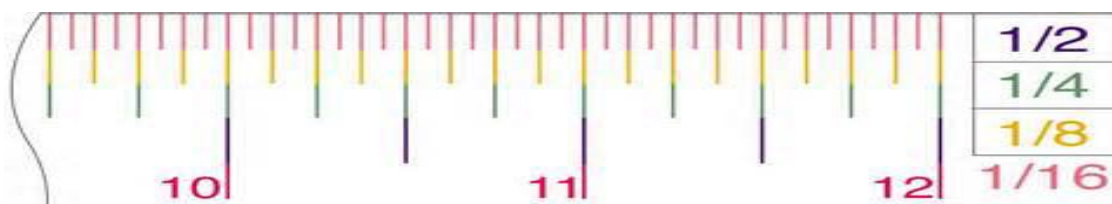

**Symbols:**

To help clarify these measurements in written form, two symbols were created. The “ symbol, when placed after a number, is the symbol for inch. The ‘ symbol, when placed after a number, is the symbol for foot. A dash between the two numbers separates the feet from inches. So, 5’-6” reads, “five feet, six inches.”

**The Tape Measure:**

Woodworkers use a tape measure. It is easy to carry and easy to use. Before you begin, examine your tape measure. The numbers next to a long line are the whole numbers. Each number represents an inch. Next, determine how many equal parts the inch is divided into. In other words, see how many lines there are between each whole number. If there are 16 equal spaces, you know the shortest line is  $\frac{1}{16}$ . The next longest line is  $\frac{1}{8}$ , after that is  $\frac{1}{4}$ , and finally the longest line between the inch marks is  $\frac{1}{2}$ . Most all tape measures are divided into 16<sup>th</sup>s, but do not be alarmed if there are more. Simply count the spaces and know the names of each line.



Now, at the end of each tape measure you will find a fastener (sometimes called a latch bracket, tang, lip, or metal hook). This marks the beginning of the measuring tape, or zero inches. When measuring, make certain your fastener is securely placed against the edge of the wood. This marks the beginning of your measurement. If it is not firmly against the wood, your measurement will be off. Also, examine this fastener before you get started. It should be not be loose. If it is loose, 0” will not be a true 0”. Finally, keep your tape tight and straight. A loose or angled measurement is longer than a tight and straight one.

**Practice Makes Perfect:**

Measure each line below. The answers are provided at the bottom of the page. If you want further practice, go online and play the game at <http://rickyspears.com/rulergame/>.

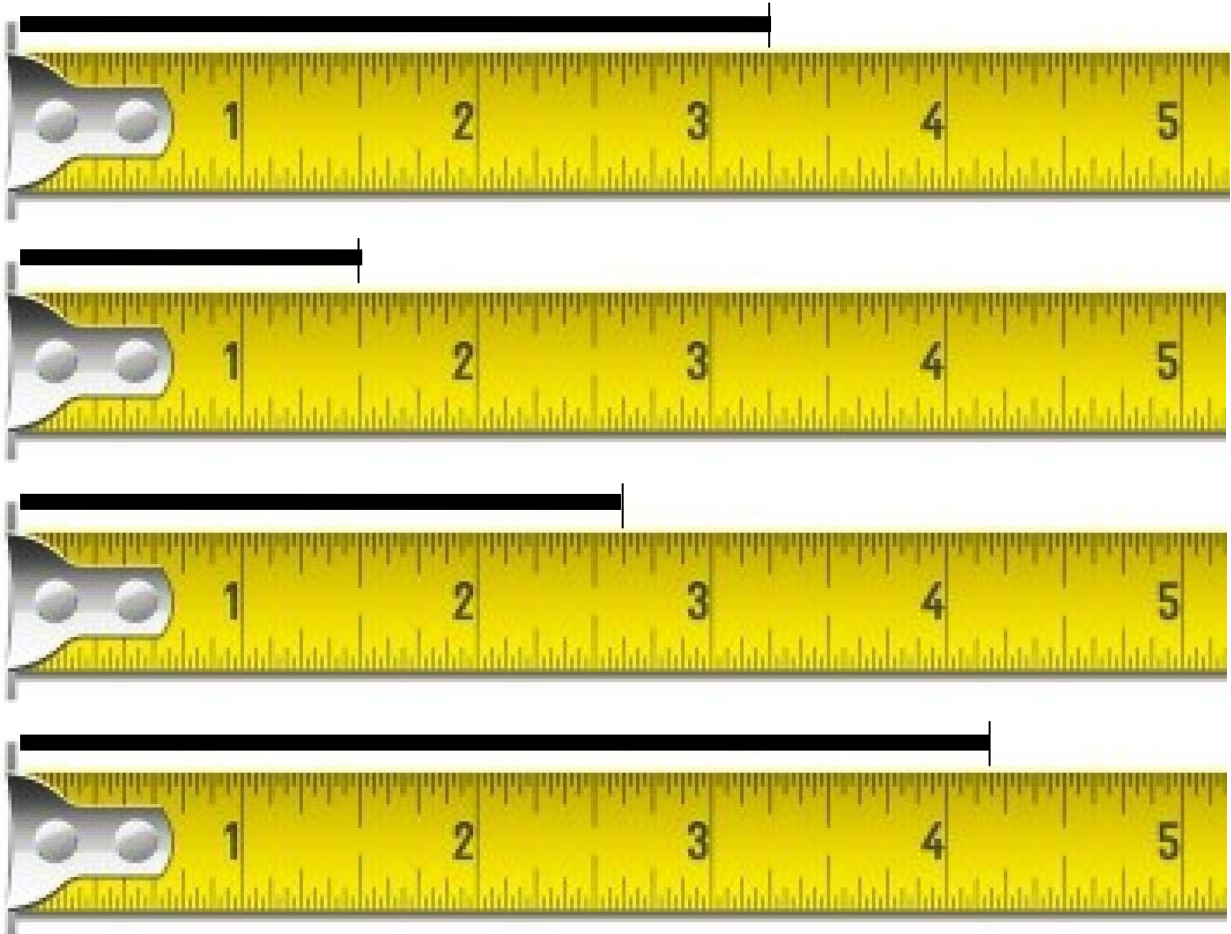

3 1/4", 1 1/2", 2 5/8", 4 3/16"



Chapter 12

## Measuring Terminology

**Introduction:**

When purchasing wood or reading a set of plans, you must know the terminology to properly identify what is needed. Boards are identified in three ways: thickness, width, and length. Think of each board as having a first, middle, and last name. When identifying lumber, these three names will always be written in same order.

**Thickness:** The thickness of the wood comes first. It is the first name of the board. The thickness is the vertical measurement of the board if it were lying flat on its widest side (see illustration).

**Width:** How wide the wood is listed next. It is the middle name of the board. The width is the horizontal measurement of the board while lying flat on its widest side (see illustration).

**Length:** How long the wood is comes last. It is the last name of the board. The length tells you how long the board is from end to end (see illustration).

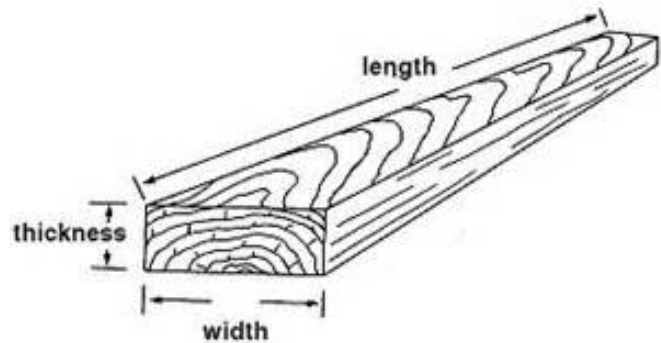

**Symbols**

The symbol you will see when the name of the board is written is the x. The x simply means “by,” or “the next way.” It is written between each number, like this thickness x width x length. A 2x4x96, then, is read, “Two by four by ninety-six inches.” That is to say that the thickness is identified as being two inches. The next way is to the width. It is four inches. The next way after that is the length, and it is ninety-six inches. Practice identifying the following names of lumber:

- |          |   |
|----------|---|
| 1x3x48   | How thick is board?<br>How wide is this board?<br>How long is this board? |
| 2x6x96   | How thick is board?<br>How wide is this board?<br>How long is this board? |
| 1x4x60   | How thick is board?<br>How wide is this board?<br>How long is this board? |
| 4x4x92 ¼ | How thick is board?<br>How wide is this board?<br>How long is this board? |
| 1/2x8x36 | How thick is board?<br>How wide is this board?<br>How long is this board? |

## Chapter 12 True Size

### Introduction:

In the last chapter we discussed how boards are identified by their first, middle, and last name (the thickness, width, and length). We might call this their formal name. However, just like people, names don't always define who we actually are. Your name might mean "Crazy Person," or "Fire Tree," but that doesn't tell us who you are. Lumber names are just like that. The name of a board doesn't tell us the whole truth about the board. It is simply the way it is identified. So, if your name means "Angry Person," you might actually be very nice. The same is true about lumber. A board might be named 2x4, but that doesn't tell us the true nature of that board. In other words, a 2x4 is not exactly two inches thick and four inches wide. Let's see why.

### Milled Lumber:

After a tree is cut down and turned into a log, it is then sent through a saw to be cut into boards. When the log is first cut, the boards are cut to the exact inch through a process called *rough sawing*. A 2x4, then, is cut out of the log exactly two inches thick and four inches wide. That is its rough sawn size. Likewise, the rough sawn size of a 1x6 is one inch thick and six inches wide, and the rough sawn size of a 4x8 is four inches thick and eight inches wide. But these are not the sizes they come to us.

At the lumberyard, after lumber has been rough sawn from the log it is also dried and planed. As you can imagine, the rough sawn boards cut from logs are not all going to be the exact same size. They are, after all, rough. They need to be smoothed and the corners need to be rounded. The planing process fixes this.

A wood planer is a large machine with round drums inside. The bottom drum turns and rolls lumber through a cutter. The top drum, or cutter, contains blades for cutting or shaving the wood. By adjusting the top drum, the millworker can determine the final size of the board. During this shaving process, the rough sawn lumber changes from rough sawn to a true size. A 2x4, then, is no longer two inches by four inches. It is smaller. This planing process allows boards around the world to be cut the exact size, which makes building homes and furniture a whole lot easier.



### Actual Size:

The standard that has been set for lumber sizes determines how much is shaved off of the board. 2x4s, for instance, have 1/2" shaved off the thickness and the width. So, the true size of a 2x4 is actually 1 1/2" x 3 1/2". But isn't calling it a 2x4 so much easier to say?

As you can see, the formal name of a board and the truth about that board are different. Look at the chart below, and see the difference between the two.

Formal Name	Actual Size	Formal Name	Actual Size	Formal Name	Actual Size
1x2	3/4 x 1 1/2	2x2	1 1/2 x 1 1/2		
1x3	3/4 x 2 1/2	2x3	1 1/2 x 2 1/2		
1x4	3/4 x 3 1/2	2x4	1 1/2 x 3 1/2	4x4	3 1/2 x 3 1/2
1x6	3/4 x 5 1/2	2x6	1 1/2 x 5 1/2	4x6	3 1/2 x 5 1/2
1x8	3/4 x 7 1/4	2x8	1 1/2 x 7 1/4	4x8	3 1/2 x 7 1/4
1x10	3/4 x 9 1/4	2x10	1 1/2 x 9 1/4	4x10	3 1/2 x 9 1/4
1x12	3/4 x 11 1/4	2x12	1 1/2 x 11 1/4	4x12	3 1/2 x 11 1/4



## Unit 4



**Introduction to Joinery**

**Squaring Wood**

**Metal Fasteners**

**Rods and Splines**

**Clamping and Gluing**

## Unit Prompts

Answers to prompts must include one reference from the class text and one reference from an internet article (dictionary and encyclopedia resources will not be accepted). Be sure to put quotation marks around your citations, number them, and place footnotes at the bottom of your paper to reference where your citation came from.

*Prompt 16: In 150 words, define “Joinery.” List and draw the six most commonly used joints in woodworking, be sure to include the benefits and strength of each.*

**Error! Not a valid link.***Prompt 17: In 150 words, explain the steps necessary for preparing wood for joining (such as squaring, planing edges, and the direction of grain).*

*Prompt 18: In 150 words, explain “Metal Fasteners.” Explain the benefits and weaknesses between hammer nailing, screwing, nail gunning, and pocket screws.*

*Prompt 19: In 150 words, describe Dowel Joints, Biscuit Joints, and Spline Joints. Be sure to include the tools used for each.*

*Prompt 20: In 150 words, explain the method of clamping and gluing wood. Be sure to explain the amount of glue necessary for a good joint and how to spread it appropriately. Also, draw a picture of five different types of clamps.*

## Introduction to Joinery

### Introduction:

Joinery is a part of [woodworking](#) that involves joining together pieces of [wood](#). Different types of joints involve:

### Fasteners

- Screws (open, plugged, capped)
- Pocket screws
- Nails (hammer and pneumatic)

### Bindings

- Metal straps, metal corners, corners
- Material straps: fabric, leather

### Adhesive

- Wood glue: Glue produces a stronger than wood connection
- Water swelling

### Wood elements

- Dowel: A wooden rod set into both pieces of adjoining wood
- Biscuit: A small wooden biscuit shaped piece is set into both pieces of adjoining wood
- Spline: Similar to the biscuit, but the “spline” runs the whole length of the joint
- Corner blocks: Square or triangular blocks placed at a joint to attach both pieces to.

### Commonly Used Joints in Woodworking:

- [Butt joint](#): the end of a piece of wood is butted against another piece of wood. This is the simplest and weakest joint.
- [Miter joint](#): similar to a butt joint, but both pieces have been cut at a 45 degree angle.
- [Lap joints](#): one piece of wood will overlap another.
- [Box joint](#), also called a finger joint, used for the corners of boxes. It involves several lap joints at the ends of two boards.
- [Dovetail joint](#): a form of box joint where the fingers are locked together by diagonal cuts.
- [Dado joint](#): a slot is cut across the grain in one piece for another piece to set into; shelves on a bookshelf having slots cut into the sides of the shelf, for example.
- [Groove joint](#): the slot is cut with the grain.
- [Tongue and groove](#). Each piece has a groove cut all along one edge, and a thin, deep ridge (the tongue) on the opposite edge. If the tongue is unattached, it is considered a [spline joint](#).
- [Mortise and tenon](#): a stub (the tenon) will fit tightly into a hole cut for it (the mortise). This is a hallmark of [Mission Style furniture](#), and also the traditional method of jointing [frame and panel](#) members in doors, windows, and cabinets.

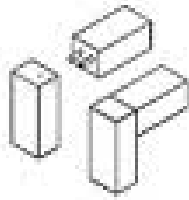

**DOWELED BUTT JOINT**

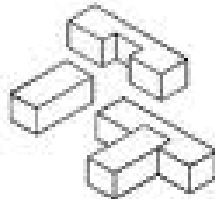

**DADO**

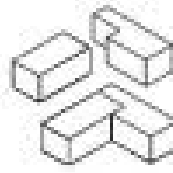

**RABBET**

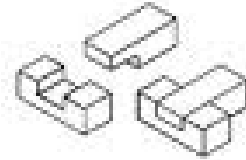

**LAP JOINT**

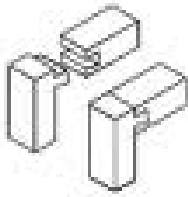

**DOVETAIL**

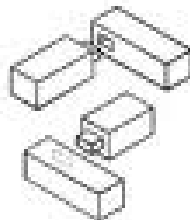

**MORTISE AND TENON**

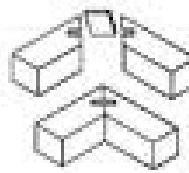

**MITER WITH  
WOOD SPLINE**

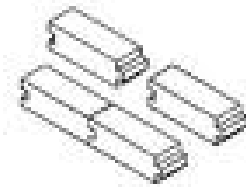

**TONGUE AND GROOVE**



**Butt Joint**



**Lap Joint**

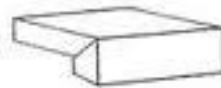

**Mitre Joint**

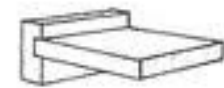

**Dado Joint**



**Dowell Joint**



**Mortise and Tenon Joint**



**Tongue and Groove Joint**



**Dovetail Joint**

Chapter 17  
**Squaring Wood**

**Introduction:**

For wood to be adjoined properly, important steps must be taken to insure maximum strength and integrity, proper symmetry, and aesthetic beauty. This is done by squaring the wood. *Squaring* wood simply

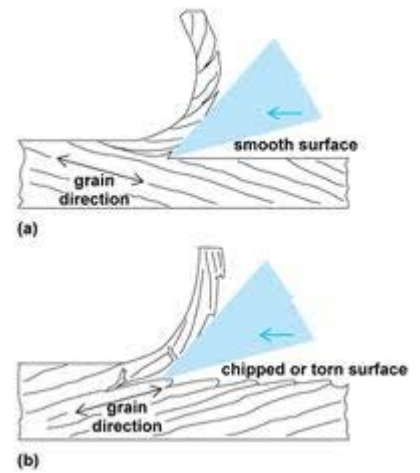



**Wane:** The presence of bark or the lack of wood fiber along the edge of a piece of lumber. It does not affect the strength of the wood. However, it is restricted in framing lumber due to the loss of a nailing edge.

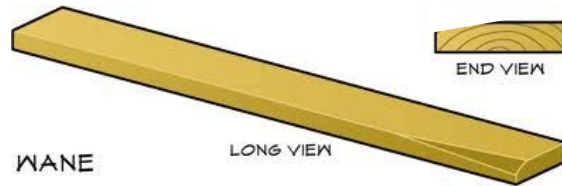

**Shake:** A lengthwise separation of wood which occurs between or through the annual growth rings. Shake often results from the tree racking in the wind.

**Knot:** One of the most prominent grading characteristics is a knot, which is a portion of a branch or limb that has become incorporated in a piece of lumber. Knots affect the strength of wood and are considered a natural strength reducing characteristic in structural lumber.

**Hole:** If a knot falls out of a piece of lumber it creates a hole. Holes can also be caused by forest insects and during manufacturing. The opening can either extend entirely through the wood or just partially, which is then often referred to as a surface pit. The hole has no more effect on the strength than the knot of the same size.

**Squaring the wood:**

- The term “square” refers to a perfect 90° angle. In other words, every face of the lumber is 90° to the adjacent edge. When wood is joined, if it is square, the two pieces will form right angles to one another. No light may be seen between boards. This assures that the glue is properly sealed to each edge with no gaps.
- Squaring wood begins with the jointer. Plane the faces first, then the edge. Once one edge is planed, use the table saw to square the final edge. Read the grain properly before planing (see above)
- Once the edges of two pieces of lumber are squared, you may begin gluing.

**Aligning the Grain:**

- When gluing two pieces of wood together along the edge, alternate end grain patterns. This prevents the assembled stock from cupping.

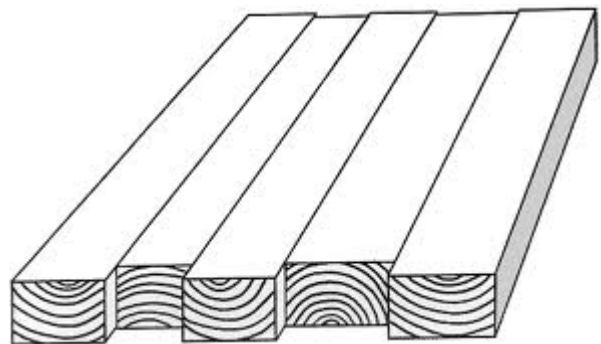

Chapter 18

**Metal Fasteners**

**Introduction:**

A metal fastener is a [hardware](#) device, such as a nail or screw, which mechanically joins or affixes two or more objects together. The most common metal fasteners used in woodworking joinery are:

1. Nails (hammer and pneumatic)
2. Wood Screws (open, plugged, capped, putty)
3. Bolts
4. Pocket screws

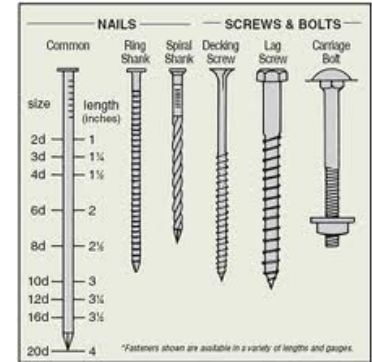

**Nails:**

There are two common types of nails you will use in woodworking, common nails and finishing nails. Common nails, used primarily in construction, have a flat head. Finishing nails, however, have a head only slightly larger than the nail shank itself and is designed for “punching” or sinking into the wood with a device called a hole punch. By doing so, the nail is pressed into the wood and recessed in such a way as to make it ready for the application of putty. This “filler” hides the nail from view and helps to maintain the natural beauty of the wood.

Nails may be inserted into lumber either manually, with the use of a hammer, or pneumatically, with the use of an air gun.

**Wood Screws:**

Unlike the smooth shanks of many nails, screw fasteners have a threaded shank with machined spirals shaped in such a way that the screw may be inserted or removed by rotating the head. There are two common thread types, coarse thread and fine thread. Coarse threaded spirals are further apart and deeper than fine threaded spirals and should be used in softwoods. Because hardwood grain is more compressed, fine threads should be used.

When using a screw fastener, you must decide how you will finish the head of the screw. You may mount the screw with its head above the surface of the wood (surface mount), flush with the surface (flush mount), or below the surface (hidden mount).

Both surface mounted or flush mounted screw heads are visible, while hidden screw heads are not. For all methods of mounting screws, a pilot hole should be employed before penetrating the lumber with the fastener. A *pilot hole* is a hole slightly smaller than the screw shank itself and is drilled through the wood where the screw will be mounted. This pilot hole prevents the wood from splitting or splintering when inserting the screw. Flush mounted or hidden screw heads require a counter sink hole. *Counter sinking* is the method of drilling a hole into the pilot hole wide enough for the head of the screw to go into. When the screw is attached, the wider hole allows the head to penetrate flush or below the surface of the wood. The deeper the counter sink hole, the further in the screw will penetrate. To completely hide the head of a screw, putty, wooden caps, or plugs may be inserted into the counter sink hole.

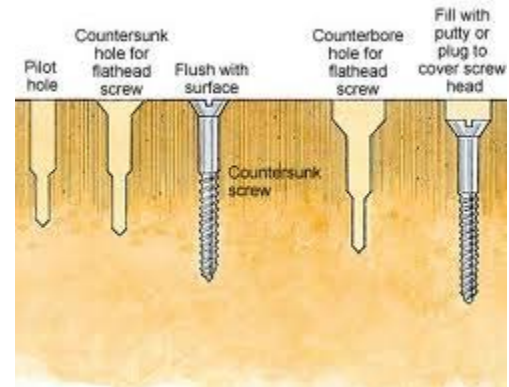

**Bolts:**

Bolts are not pointed like screws or nails and are not driven into wood. Rather, holes the size of the bolt must first be drilled through both pieces of wood to be adjoined. Bolts have flat heads and are designed to use a nut or a threaded insert. The nut, often used with a washer, is attached to the end of the bolt and tightened with a wrench to squeeze the two pieces of wood together. Inserts are recessed into the wood and creates a threaded hole for the bolt.

Carriage bolts have smooth heads and may only be tightened with a nut. Standard bolts have a hex head for applying a wrench.

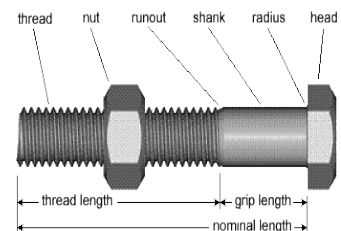

**Pocket Screws:**

Pocket screws get their name because they are recessed into the wood in an angled counter sink called a pocket. They are designed to provide fast, strong, and evenly matched joinery. There is little difference between a pocket screw and a standard wood screw, though the head is wider and not tapered, and the screw tip is designed to self-tap. That is to say, the pocket screw has a stronger head and is fashioned to go into the wood without a pilot hole. The thread classifications with pocket screws are the same as with any type of screw - coarse and fine - and should be used accordingly as stated above.

Pocket holes are constructed using a jig - a device used to hold stock in the same position so that repetitive cuts or holes may be made quickly. The pocket hole jig holds the lumber in place and provides angled sleeves designed to guide a uniquely made drill bit into position.



Chapter 19

**Rods and Splines**

**Introduction:**

To provide strength to wood joints, wooden rods or splines may also be inserted, glued in place, and then clamped together. The most common rod and spline joints are:

- **Doweled joints:** A wooden rod, called a dowel, is inserted and glued in both pieces of wood and then clamped together. In the old days, water was used instead of glue. Since water causes wood to swell, the dowel would swell in the wood and secure it.

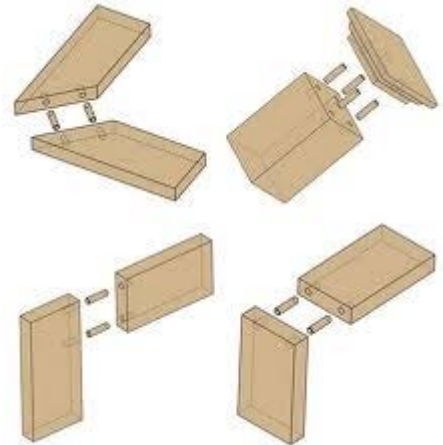

- **Biscuit joints:** After cutting a slot into the two pieces of wood to be adjoined, an oval-shaped, highly-dried and compressed wooden biscuit (usually made of [beech](#) wood) is covered with glue and inserted in place. The boards are then clamped together until adhesion is complete.

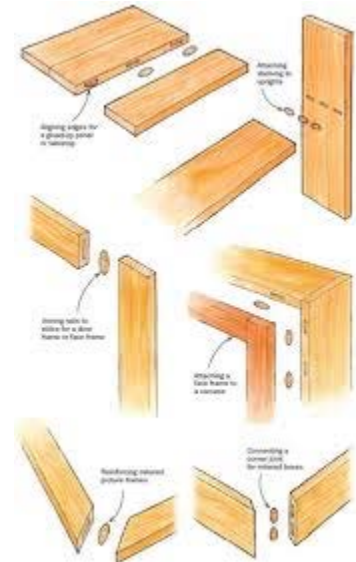

- **Spline joints:** A spline is a thin piece of wood inserted into two matching slots cut into wood joints, much like a biscuit. A spline, however, typically is visible and added to beautify the project.

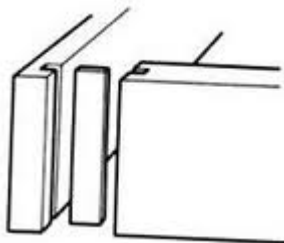

### Steps to creating a Dowel Joint

- **Dowel Jig:** Dowel jigs are used to insure straight, centered, and aligned holes on each piece of wood to be adjoined.
  1. Set up the jig with the desired dowel size,
  2. Acquire the correct drill bit
  3. Set up the jig to drill in the center of the joint (use a scrap piece of lumber until it is correct).
  4. Determine the depth of the drill cut then mark it with a piece of tape
- **Mark centers:** Layout the wood to be adjoined and mark both pieces by drawing a line on each.
- **Attach Jig:** Locate jig at center marks. Do not clamp so tightly that you mark your wood.
- **Drill holes:** When doweeling edge-wood to face-wood, drill edge-wood first using the jig, then insert dowel centering tool, mark location on face-wood, then drill dowel hole.
- **Insert Dowels:** Make certain dowels are cut to the right length. Apply glue to dowel holes on one edge, insert dowels, apply glue to corresponding edge, and clamp together



### Steps to creating a Biscuit Joint:

- **Biscuit Jointer:** A biscuit jointer is the tool used to cut grooves into wood joints for inserting biscuits.
  1. Set up the jointer to the desired biscuit size and depth
  2. Set the miter gauge to the desired angle of cut
  3. Set up the cutter to cut in the center of the joint (use a scrap piece of lumber until it is correct).
- **Mark centers:** Layout the wood to be adjoined and mark both pieces by drawing a line on each.
- **Cut slots:** Using the center marks, cut the biscuit slots.
- **Insert Biscuits:** Make certain biscuits are the right size. Apply glue to slots on one edge, insert biscuit, apply glue to corresponding slots, and clamp together



### Steps to creating a Spline Joint:

- **Table Saw:** Spline grooves are made with a table saw using a tenon jig (for miters) and the fence for edges.
- **Cut the groove:** Locate the desired placement of the groove and cut accordingly.
- **Cut the spline:** The proper grain direction is crucial when creating a spline. Make certain the grain is running lengthwise.
- **Insert Spline:** Make certain splines are the right size. Apply glue to grove on one edge, insert spline, apply glue to corresponding groove, and clamp together



## Clamping and Gluing

### Introduction:

Clamping and gluing wood is the process used for joining stock together with the force and adhesion necessary to assure strong wood joints. This is accomplished by using *clamps* and *wood glue*. Surprisingly, when wood is glued together, it forms a stronger-than-wood bond. That is to say, the wood will break before the glued joint will break. This fact alone makes gluing a valid option to consider when adhering wood. Other methods may be employed to aid in the process, such as biscuits, dowels, nails, and screws, but a properly glued butt joint is not to be underestimated.

### The Gluing Process:

Before you begin gluing, make certain you have all the necessary tools and equipment on the table with you.

First, decide what type of clamp you will use. A *clamp* is a device used for pressing two pieces of stock together. There are many different types of clamps, and all vary in the amount of pressure they may exert on the stock. Below is a list of the most popular wood clamps in use today.

#### Types of clamps

- Bar clamp
- Wood clamp or Hand screw clamp
- C-clamp
- Spring clamp
- Screw clamp
- Strap or band
- Screw clamp
- Toggle clamp
- Pipe clamp
- One handed bar clamp
- Miter clamp



The type of clamp you choose is determined by the size and amount of pressure you need. Pipe clamps, for instance, are long and have the greatest cranking power. Adversly, spring clamps are small and have less compression strength.

Once you have chosen the clamp(s) most suitable for your project, acquire the clamping tools you will need. A clamping tool is any device useful for the gluing process. Below are a few.

### Clamping tools

- **Cauls:** Rigid wooden planks that are clamped to panel glue-ups, one on top and another directly below it, to keep the individual boards aligned to each other (right).
- **Cellophane Tape:** Attached to cauls to prevent from sticking to excess project glue
- **Wax paper:** Prevents projects from bonding to the table
- **Riser blocks:** Lifts project off the table for ease of clamping
- **Squares:** Allows you to check if stock is square (90°)
- **Wet paper towel:** Excess glue is the enemy of stain! Remove it before it sets. When glue sets, it seals the wood and prevents stain from soaking into the fibers. The result is one big ugly yellow mark. To avoid excess glue, don't apply more glue than what the joint can allow. If glue does squeeze out onto your project, wipe it immediately with the wet paper towel.

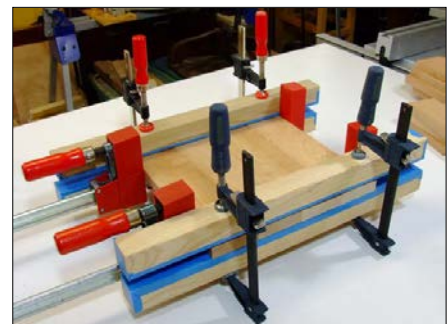

**Clamping Wood for Glue Joints**

The method for gluing a wood project is simple, but proper steps must be taken to assure success. By following the steps below, you will be well on your way to creating a fine glued joint.

Gluing methods:

- Always dry clamp before gluing: A dry clamp is when you clamp everything together without the glue. This allows you to think through the process, eliminate surprises, work quickly once glue is applied, and determine the required clamps.
- Rotate growth rings on plank glue projects. Because wood is constantly moving, especially in damp climates, when gluing planks together use the direction of the growth rings to your favor. By alternating them, each plank will pull in opposite directions and keep your glue-up from warping (see illustration to the right).
- Apply glue to both sides of wood joint. A joint glued on one piece of lumber alone is only half as strong as when applied to both pieces.
- Do not *starve* your joint. Starving is the term used when an inadequate amount of glue has been applied to the joint. A starved joint is weak and will easily break apart.
- Know when to apply a lot of glue. If you will be running your project through a planer after it has been glued, be generous with the amount of glue you apply. The excess will be removed later by the machine.
- After you have applied a bead of glue to the wood edges, wipe it flat using a finger, brush, or stick, but don't remove it. This will help assure proper coverage of the glue over the entire joint.
- Clear excess glue immediately after clamping before it hardens, otherwise it will seal your wood and leave an ugly stain mark. Scrape the glue off with a scraper or wet cloth. Do not use your hand to wipe glue, that will only disperse the glue and press it into your wood. Scrape using a lifting motion.

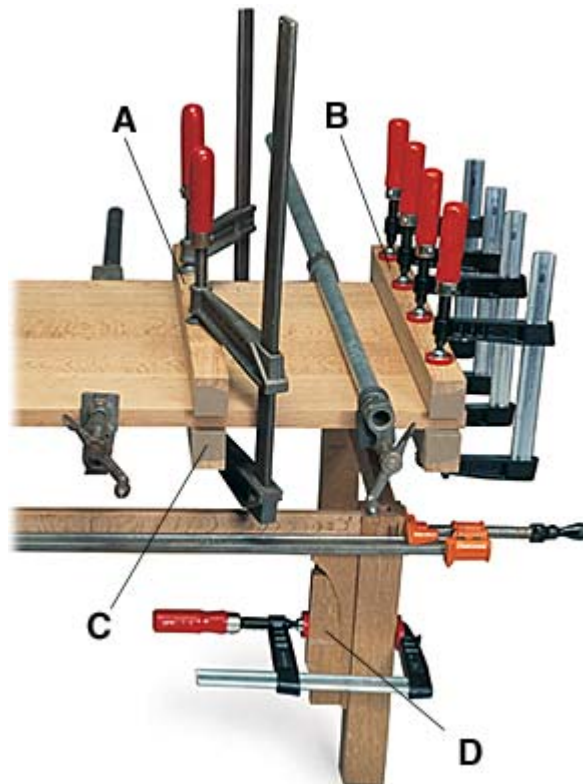
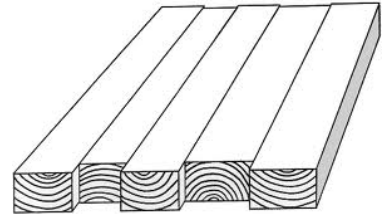





## Unit V



**Surface Preparation**

**Friends and Foes**

**Wood Staining**

**Top Coating**

**Oil and Wax**

**Unit Test**

## Unit Prompts

Answers to prompts must include one reference from the class text and one reference from an internet article (dictionary and encyclopedia resources will not be accepted). Be sure to put quotation marks around your citations, number them, and place footnotes at the bottom of your paper to reference where your citation came from.

*Prompt 21: In 150 words, explain how to best prepare a project for finishing (filling, plugging, and sanding). Be certain to include keys to sanding properly (how to avoid scratch marks, the proper grit to us, etc.).*

*Prompt 22: In 150 words, explain the importance of “light” in the finishing process. Also, explain the enemy of “dust” in the finishing process.*

*Prompt 23: In 150 words, explain the steps necessary for staining a project and at least three different methods for applying stain.*

*Prompt 24: In 150 words, list at least three different types of topcoats and explain the steps necessary for accomplishing a smooth finish on your project.*

*Prompt 25: In 150 words, explain the role oil and wax can play in the finishing process and the benefits/uses of each.*

## Chapter 21

## Surface Preparation

**Introduction:**

*Finishing* is the term used to describe the coloring, embellishing, or protecting of a wood surface. Special care must be taken to assure this final step of construction is done properly. If it is not, the beauty of your project will be ruined. Similar to shop safety, your enemy to a good finish is impatience. Take the time necessary to assure the beauty of your project is enhanced by taking special care during this stage of construction. In a way, whether your project is seen as a work of art or a pile of junk rises and falls on your finish...and finish rises and falls on proper preparation.

To properly prepare your project for finishing, you must pay careful attention while laying out, cutting, assembling, and sanding your project. Pencil marks left on wood during the layout phase of construction are nothing but a nuisance later on. Likewise, burn marks caused from improper use of tools or from dull blades make for unpleasant eye sores. Also, the unsightly look of excess glue, nail heads, or poorly applied wood filler is only enhanced with the application of stain. Finally, inadequate and incorrect sanding of your project distorts the color, blackens wood, and leaves behind obvious scratch marks. Below is a short explanation of the cause of unsightly marks.

**Unsightly marks**

- Pencil marks: Caused by drawing lines on wood
- Burn marks: Caused by blades or bits cutting the wood too slow (often because of dull edges)
- Wood filler marks: Caused by applying too much filler and not sanding appropriately
- Glue marks: Caused by excess glue spilling out from a joint. This unseen enemy radically changes the color of stain because it seals off wood fibers/cells and prevents the stain from absorbing.
- Sanding marks: Caused by improperly used *grit* and sanding in the wrong direction

**The Layout:**

*Layout* is the term used to describe the process of marking your wood for cutting. During this process, use a pencil, not a pen. Pencil marks alone are not easily dealt with, pen marks are even worse. Make a simple little straight mark or a > at the point where the blade first touches the wood. **DO NOT DRAW LINES.** The machines will cut straight for you. You do not need to follow lines when using machines. Lines are only necessary when making freehand cuts with hand tools.

**Burn Marks:**

If you cut too slow or if your blade is dull, you may burn your wood. No, the wood does not catch on fire, but it does turn black, and if you think removing pencil marks is hard burn marks will seem impossible. So, pay attention to the smell of your wood when you are cutting, and do not push too slow.

**Dealing with Glue:**

Perhaps the greatest threat to a well-built project is handling excess glue inappropriately. It doesn't matter how great of a job you have done constructing your project, if you leave behind glue your project will not look good. Follow these two easy steps:

- Don't be messy: The best way to deal with glue is "Don't make a mess." Use the proper amount of glue so that extra does not spill, drip onto, or press out of your project.
- Remove excess glue immediately, but **DO NOT WIPE IT** with your fingers! If you wipe glue, it spreads and seals into your wood. As a result, no stain will penetrate into the wood. Use a knife or putty knife to lift glue from the surface. After you have lifted the glue, use a damp cloth to clean away any remaining glue. Of course, introducing water to wood will cause the wood pores to lift, so you will need to sand the lifted area with fine grit sandpaper.

**Proper sanding tips:**

Finally, use correct sanding methods. I haven't met a woodworker yet that hasn't said, "I hate sanding." It's tedious, I know, but it has to be done and it has to be done properly. Here are some tips:

- Understanding *Grit*. Sandpaper is made by gluing sand onto paper. *Grit* is the term used to describe the amount of sand granules glued onto a square inch of sandpaper. Because large pieces of sand take up more space, the less will fit into a square inch. Therefore, the lower the number of grit, the larger the sand granules. When the number is low (i.e. the grit is bumpy), the sandpaper is considered *coarse*. The lower the number (or more coarse) the more likely the sandpaper will gauge or scratch your wood. Coarse sand paper, then, is used for removing large amounts of wood. Medium and fine

grade of sandpaper are generally used in refinishing furniture and antiques. Coarse grits (those under #100) damage a fine wood finish. Medium grits, such as #120 and #150, are useful for removing old finish or scratches. Fine grits, such as #220, are frequently used for a final light sanding just before applying stain to the wood. The rule of thumb is: If the wood is rough, use rough (or coarse) sandpaper. If the wood is smooth, use smooth (or fine) sandpaper.

- Work your way up the grit table: Start with coarse sandpaper and end with fine. When using sandpaper, you are actually closing the pores in wood. Polished wood, for instance, has been buffed so smooth with fine grit sandpaper that stain will hardly absorb into the wood. When sanding, start with coarse grit sandpaper (#60, #80) for shaping, removing burn marks, or removing large amounts of lumber. Then, move to a medium grit (#120, #150) and remove unsightly marks or the scratches left behind by the coarse sandpaper. Then, finish with a fine grit paper (#220) to smooth out. Any rough spots on your wood are wide open pores and absorb the finish in such a way that it turns out much darker.
- Sand in the correct direction: **ALWAYS SAND WITH THE GRAIN.** Grain is the fiber in wood, the pattern of which appears as lines. The direction of these lines indicates the direction of the grain. Sanding with the grain (#2 on the right) means to sand in the same direction as the lines in the wood. When you sand cross-grain (or “against the grain”) as seen in #1 to the right, unsightly scratches will occur and often not be seen until the project is stained. See image below.

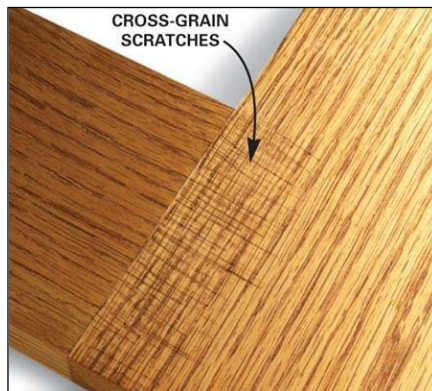
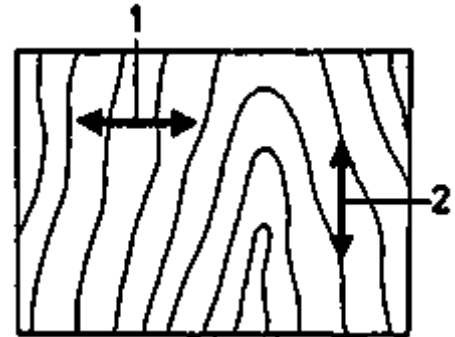

**Sanding Tools**

- Sandpaper: Paper with glued granules of sand attached to rub against wood and remove wood particles.
- Sanding block: A hard substance formed to fit your hand for attaching sandpaper. Blocks provide a truth, flat surface to sanding that evenly removes material. Your finger is soft and therefore bends with the contour of the wood.
- Electrical sanders: Regardless of the type of electrical sanders used, the same rules of sanding apply. Some sanders are the Disc Sander, the Belt Sander, the Orbital Sander, and the Hand Sander (belt, disc, and drum). Palm sanders are useful for finish sanding and help the process move along a lot faster.

## Chapter 22

**Friends and Foes****Introduction:**

Before you begin finishing your project, you should pay close attention to the environment in which you are working; it can be friendly or unfriendly. The following tips should help

**Friends:**

- **Good lighting:** Good lighting is essential. Use direct light to reveal runs, blemishes, missed areas, etc. This means you will need to move your project or yourself around to allow the light to do its business.
- **No Mess:** Make certain the area is clean around you. Nothing should obstruct your work once you get going.
- **Good Ventilation:** Do not do finish work in a closed area without proper air flow. Fumes can be dangerous, not to mention give you a terrible headache. Also, make certain winds or breezes cannot come into your work area, they carry particles that could adhere to your project.
- **Clean Applicators:** An applicator is the method by which you will apply your finish. The most common and basic methods of applying finish are with rags or brushes. Make certain your applicator is clean, dry, and free of loose material (detached brush hairs, threads, excess material, etc.). These will come off and stick to your project. Some shops are equipped with spray booths, which require special attention.
- **Supplies:**
  - Stir Stick:** Stains should always be stirred gently before beginning your project because heavier color pigments settle on the bottom of the can.
  - Paper towels and rags:** Clean-up messes immediately! Don't leave puddles of finish behind for someone to deal with.
  - Rubber Gloves:** Besides keeping your hands clean, gloves help prevent the oils in your skin from affecting your stain.
  - Aprons:** If you do not wish to damage your clothes, aprons are suggested.
  - Drop Cloths:** If you are staining on the floor, use a drop cloth. This will help prevent particles on the floor from adhering to your project.
  - Safety Glasses:** As always, wear your glasses. Droplets of finish liquids and fumes can burn your eyes.

**Foes:**

- **Sawdust:** Finish areas and sanding areas should be separated. Floating dust particles will adhere to your project and ruin the finish. Never sand near the finish area.
- **Sloppy stainers:** Protect your work from sloppy stainers by putting your finished project someplace safe. Don't leave it on the staining table. Some people are much too aggressive when staining and send droplets everywhere. You can't change them but you can save your project. Put it in a safe place. Likewise, don't be a messy stainer. The staining process is slow and easy, gentle and fluid. Take your time....And clean up after yourself.
- **Messy people:** Clean up is crucial. After you finish staining or applying your topcoats, clean up your brushes with paint thinner. Stain and Polyurethane are oil based materials, which means you cannot wash them with water. You must use paint thinner to clean your brushes. Rags should be put in the proper disposing can.

## Wood Staining

### Introduction:

Though the natural beauty and color of wood is enough to distinguish any wood project, some choose to color their projects with *stain*. Wood finishing stain is nothing more than colored dyes or pigments added to oil-based mineral spirits or water, which can be purchased in a number of different shades.

As in every other stage of woodworking, staining requires patience and gentleness. In other words, don't rush and follow these important tips.

### Important tips:

- **Prep well:** Glue marks and pencil marks simply “shout” their presence on wood after it has been stained. Because the stain is not able to absorb into the areas where glue and marks remain, it will stand out as one big ugly spot. Remove glue and marks before staining.
- **Sand well:** Because stain absorbs into wood pores, the better the sand job the better the finish. Why? Because wood that is sanded well smoothes or diminishes the size of the pores in the wood, which in turn allows for a more uniform color. Think of wood as a sponge. It will soak up your stain. If pores have not been properly sanded, large open pores soak up the stain and a darker color appears. You should end your sanding with at least a 220 grit sandpaper.
- **Pre-test your stain:** Not all wood is the same. Wood varieties will respond differently to color. Always test your stain on a similar piece of wood before applying it. By doing so, you will determine if the color is exactly what you want.
- **Choose the right stain:** Stain can be made from oil-based mineral spirits or water. The differences include:
  - OIL-BASED PRODUCTS.**
    - Give you a longer working time, enabling you to stain floors, cabinets, paneling, and doors without the worry of dried lap marks.
    - Do not raise the grain, eliminating the need for additional sanding.
    - Are applied with a natural bristle brush, while water-based products must be applied with a synthetic brush.
  - WATER-BASED PRODUCTS.**
    - Are low odor.
    - Dry faster, enabling you to stain and finish in one day.
    - Require only soap and water for clean-up.
    - Come in a wider range of vibrant stain colors.
- **Choose the right method for application:** Stain can be applied with a bristle brush, a foam brush, an aerosol can, or a cloth. On woods with large, open pores, such as oak, mahogany and ash, increase your pressure to work the stain into the pores. Rubbing or brushing against the direction of the grain will help fill deep pores with stain. Apply a liberal amount of stain, giving the wood an ample amount to absorb.
- **Stir baby stir:** Pigments and dyes settle to the bottom of the can. Be sure to always stir the product before using it. If you do not, the colors in the stain will not be properly mixed and a different color will appear.
- **Timing:** Pay attention to how long you leave the stain on the wood before wiping off the excess. The longer the stain is left on, the deeper and richer the color will be. For consistent color, use careful timing. Never allow any excess stain to dry on wood surface—it will cause all sorts of difficult issues.
- **Wipe off:** Remove the last of any unabsorbed stain with a dry cloth. Wipe only in the direction of the grain. Swirl marks left by a stain-saturated cloth will become even more obvious under a coat of clear finish.
- **Second coat warning:** Applying a second coat will darken the color.

### Clean up:

- **Know what works:** Water and soap will not clean oil based stains. Use mineral spirits or paint thinner to clean stain brushes. **DO NOT CLEAN STAIN BRUSHES IN THE SINK!**
- **Clean immediately:** As soon as you are finished using a brush, clean it in mineral spirits and place it on the brush rack. When oil-based stains dry on a brush, the brush is ruined and must be thrown away.

## Top Coating

### Introduction:

Once your project has been stained to the desired color, it is time to apply the top coat. A top coat over stain is a translucent layer of finish often called a lacquer coat, varnish, or poly urethane coat. Opinions vary on which is best. The purpose of the top coat is to preserve the beauty and protect the surface of the project. Top coats help enliven (draw out, accentuate, etc.) the grain and enhances the beauty of the wood while at the same time hardening to protect it from dents and scratches.

### Water-base vs. Oil-base Top Coats:

- Yellowing: In time, oil-base top coats will yellow, water-base will not.
- Durability: Both supply a tough hard coat. Oil is known for drying harder.
- Drying time: Water-base will dry faster than oil-base top coats.
- Clean-up: Water-base is easier to clean up because it only requires water. Oil-base top coats must be cleaned with a solvent (paint thinner, mineral spirits, etc.)

### Application methods:

- Get it right: Oil-base top coats must be applied to oil-base finishes. Likewise, only water-base top coats should be used for covering water-base finishes. If this step is done incorrectly, the top coat will not stick.
- Choose the right sheen: Sheen or gloss is the word we use to describe the reflection or shine of a top coat. Gloss comes in different categories. From high reflection to low reflection, they are rated as follows: High Gloss, Semi-Gloss, Silk, Satin, Eggshell, Matte, and Flat. High Gloss, for example, will reflect a lot of light (like a mirror) while flat will reflect very little. Even though a high sheen sounds pretty, be aware that in full light the reflection can all but erase the grain and color of your project (see picture on the right).
- Stir: Mix your top coat well by stirring, not shaking. Shaking can create air pockets and put bubbles in your finish.
- Applicators: Top coats may be applied by using a sprayer or brush (foam or bristle). In some cases, a cotton rag may be used, but only with special wipe-on polyurethane. These wipe-on coats are much thinner, but the risk of runs and sags is minimal.
- Apply at least three coats: Top coating is a three coat process. Take a look at your bathroom cabinets at home and you'll typically see the results of a one coat application: peeling, fading, and flaking. After each coat, wait a minimum of eight (8) hours before sanding. Sand lightly with 220+ grit sandpaper to remove any imperfections, runs, or bumps. Then wipe clean with a dry cloth. Finally, add your next coat. Continue this process until you are satisfied with the finish. Remember, each layer you apply is a new "sheet" of protection. This also means you are getting further and further away from the woods natural feel.
- Be gentle: Applying a top coat is a slow gentle step. Roll, spray, or brush in direction of the grain with calm, easy strokes. Moving too quickly can create air bubbles or uneven layers. Go slow. Be gentle. Impatience has ruined many a well-built projects.
- Use your light: Top coats are tricky, and if you don't pay attention you will have many runs and sags. Adjusting the direction by which you are looking at your project as you coat it will help use the light to point out such imperfections.
- Clean up! Clean up your brush immediately, especially if you are using oil based finish, seal the can, and put everything away. Remember, you must clean with paint thinner for oil based finish.



## Chapter 25

**Oil and Wax****Introduction:**

Because finish coating with lacquer or poly-urethane is time consuming and steals away from the natural feel of wood - some would even say it steals away the natural beauty as well - one option is to oil and wax your project. People choose this method for three key reasons. Firstly, the finish product is easier to maintain. Other finishes fade, peel, and crack. Not so with oil and wax. Simply apply new coats when it is needed. Secondly, oil and wax is much easier to apply. Lastly, because the oil absorbs into the pores, the natural color and beauty of wood is accentuated (unlike stains, which color it). While the hard surface of lacquer or urethane protects the surface of your project, an oil and wax finish will still provide a thin protective film that allows the natural beauty of your wood to shine through. To some woodworkers, oil and wax simply feels and looks right...like wood should feel and look.

In some cases, such as finishing salad bowls, goblets, cutting boards, or any other item used for storing, preparing, serving, or holding food or drink, butcher block oil should be applied instead of poly-urethane, lacquer, or any other finish. Such topcoats can crack or be damaged by cutlery. Butcher block oil, on the other hand, cannot be damaged because it has soaked into the wood. This absorption seals the pores, which prevents moisture from penetrating into the wood and forming a bacteria breeding ground.

**Application:**

“The secret to an oil and wax finish is how the two parts work together. First, the boiled linseed oil soaks into the wood to give it a warm glow and creates a thin protective layer. The color and figure of cherry, walnut, maple, and even oak will really “pop” after just a single coat of linseed oil. But the oil alone has no shine. And that’s where the wax enters the picture. A thin coat of paste wax rubbed over the oil and then buffed out will add another layer of protection and leave a soft sheen that can’t be beat”

([www.woodsmith.com/files/issues/sample/sample-46-47.pdf](http://www.woodsmith.com/files/issues/sample/sample-46-47.pdf)).

**Step One: Prepare the surface**

“To reveal the wood’s figure and luster, sand using P220-grit paper, paying particular attention to end grain and sharp corners. Wipe the whole piece with a damp cloth to raise the grain. Then lightly sand the wood with 400-grit paper (CAMI). Finally, polish the whole surface with either a gray abrasive pad or 0000 steel wool. This allows the oil applied next to penetrate evenly and reduces the chances of blotching.

**Step Two: Apply the linseed oil**

Flood the surface with boiled linseed oil and wipe it around with a cotton cloth. Allow the oil to penetrate the wood for an hour and then wipe the surface dry with a clean cloth. Wait two days, and then apply more oil in the same way as the first time. If any areas still absorb oil, wait two days and apply a third coat of oil. Remember, to avoid spontaneous combustion of oils, which can cause fire, be sure to spread the used cloths outside to dry before disposing.

**Step Three: Wax the piece**

After the last coat of oil has dried for two days, rub the surface with a white abrasive pad to smooth away any small dust nibs. Then wipe on a coat of paste wax. If you wish to darken the appearance you can use a colored wax. Wait for thirty minutes, and then buff the surface with a piece of soft cotton cloth.”

(<http://www.finewoodworking.com/SkillsAndTechniques/SkillsAndTechniquesArticle.aspx?id=30413>)





## Unit VI



**Introduction**  
**Ethical Standards**  
**I-management**  
**Stress Management**

# work ethic

## Unit Prompts

Answers to prompts must include one reference from the class text and one reference from an internet article (dictionary and encyclopedia resources will not be accepted). Be sure to put quotation marks around your citations, number them, and place footnotes at the bottom of your paper to reference where your citation came from.

*Prompt 26: In 150 words, define “Work Ethic”*

*Prompt 27: Create your own “Code of Work Ethic.” List at least five work ethic standards you will strive to live by and explain what each means to you..*

*Prompt 28: In 150 words, explain what it means to be self-motivated and to take initiative.*

*Prompt 29: In 150 words, explain what it means to manage your time wisely and how you plan on being a good time manager.*

*Prompt 30: In 150 words, explain what it means to you to be a “hard worker.”*

## Introduction to Work Ethic

### Introduction:

*Ethics* is a term used to describe a person's moral philosophy. Their ethic is what they consider to be right or wrong behavior – what ought to be and what ought not to be. When applied to work habits and practices, the set of values a person applies to the way they work is called their *work ethic*. If a person has a poor work ethic, for example, they are typically considered lazy, unmotivated, unreliable, excuse makers, and unaware. On the other hand, people who have a good work ethic are typically considered hard working, diligent, attentive, honest, and driven to learn more. Though cultures vary, a common definition of a strong work ethic seems to be woven into us all. While westerners tend to place high value on “keeping busy” and “completing quickly”, other cultures may view “being in relationship” or “value resting over rushing.” It is the pursuit of excellence as it is defined by the culture in which a person lives that defines a good work ethic. The truth is, the people who are more diligent to complete a task are more respected in their communities.

### Benefits:

Having a good work ethic has its benefits. Listed below are a few.

- **A good reputation:** Having a good name is better than being rich. When others know that you are reliable, industrious, and determined you experience a wealth in relationships that surpass riches.
- **Peace of mind:** A cluttered room is a cluttered mind. When things around you are messy, disorderly, or incomplete, the mind has little rest. People are made for some sense of order; it's why we feel so at peace when we go to the mountains or the beach where everything seems to be in undisturbed balance. When you work hard to bring order to your life, life becomes more peaceful.
- **Greater rewards:** When you have a good work ethic you are trusted with more responsibility, and with more responsibility come greater rewards (higher pay, the trust of others, value, etc.).
- **Sense of security for others:** With a good work ethic, the people who rely on you feel secure. They are not worried because they know your hard work will take care of what needs to be done.
- **Increased knowledge:** Those who are willing to work hard typically discover more. They risk trying something new and learn different approaches to make things work.
- **Confidence:** When you work hard to complete a job with the best your ability it builds the confidence to do it again or to try something of greater difficulty.
- **Satisfaction:** Working diligently to complete a job feels good. Satisfaction in a job well done is a great feeling.
- **Health:** A good work ethic is reflected in everything you do. If you are willing to work hard at work, then you are typically prepared to work hard to promote your own physical, social, emotional, spiritual, and mental health as well. Simply put, having a good work ethic will benefit every facet of your life.
- **Self-sufficiency:** Hard workers tend to be more self-reliant. They don't expect others to take care of them; they are content to take responsibility for themselves. They are not afraid of hard work or difficult times because they know how to survive on their own.
- **Benefits others:** By working hard you benefit others: a boss, your employer, fellow employees/students, family members, your friends, and the needy. A strong economy is built this way, and the needs of the unfortunate are met. By doing so you discover that it is better to give than to receive.

### Determining your work ethic

To determine your work ethic, you must first decide what you value. Then, ask yourself if what you value is marketable (will people want it?). For example:

- Will your future boss want someone who always complains?
- Will your spouse want someone who is lazy?
- Will putting off things make your life more peaceful?
- Would you want to hire someone with your work ethic? Why?

## Work Ethic Standards

### Introduction:

A good work ethic is like the language of a culture, everyone understands what it looks like. There are standards by which all people measure a person's work ethic. As you prepare to write your own code, you should reflect upon these standards and consider which you will live by. It is important that you reflect upon the principles you will hold dear. Below are some "Work Ethic Codes" you may want to consider before writing your own.

### Work Ethic Codes:

Read over the following work ethic codes. Do you see any similarities? What standard principles do you see?

#### The Environment Protection Department, United States Government

1. **DISCIPLINE:** Perform with full discipline by practicing true values as well as taking actions in accordance with existing rules and regulations.
2. **CREDIBILITY:** Demonstrate excellent credibility in performing duties and responsibilities.
3. **SPIRIT OF COOPERATION:** Work in the spirit of cooperation by assisting one another.
4. **SKILL AND COMPETENCY:** Strive to acquire knowledge in order to enhance skill and competency, and to achieve excellence in performing duties and responsibilities.
5. **OFFICE HARMONY:** Maintain work environment that is orderly, clean and harmonious.
6. **DRESS:** Dress in smart and polite attire in accordance with the approved dress code.
7. **BALANCE LIFE:** Practice a healthy and balance life by allocating sufficient time for work, rest, recreation and spiritual obligation.
8. **BEHAVIOUR:** Have an attitude that demonstrates politeness, respect and forgiveness among one another.
9. **OPENNESS:** Receptive to views, suggestions, criticisms and ideas from other members of the Department or the public with an open and positive mind.
10. **VALUING TIME:** Skillful in planning and utilizing limited time in performing tasks, making decisions and achieving the desired outputs.

#### American Staffing Association (abbreviated)

1. To comply with all laws and regulations (Law abiding)
2. To treat all applicants and employees with dignity and respect (Dignity and Respect)
3. To maintain high standards of integrity. (Integrity)
4. To determine the experience and qualifications of applicants and employees. (Fairness)
5. To explain to employees needed information (Effective Communication).
6. To ascertain appropriate work sites for employees (Safety)
7. To take prompt action to address employee questions, concerns, or complaints (Proactive)

#### Raytheon Company

##### **Value People**

Treat people with respect and dignity.  
 Welcome diversity and diverse opinions.  
 Help our fellow employees improve their skills.  
 Recognize and reward accomplishment.  
 Foster teamwork and collaboration.

##### **Value Integrity**

Be honest, forthright and trustworthy.  
 Use straight talk; no hidden agendas.  
 Respect ethics, law and regulation.

##### **Value Commitment**

Honor commitments to customers, shareholders, the community and each other.  
 Accept personal responsibility to meet commitments; be accountable.

##### **Value Excellence**

Improve performance continually.  
 Stress quality, productivity, growth, best practices and measurements.  
 Always strive to be the best.

**Valley Oaks Charter School, Student work ethic**

1. **Academic Excellence:** To be an academic achiever by having a passion for life-long learning.
2. **Effective Communication:** To demonstrate competence in oral, written, illustrative, and artistic communication.
3. **Critical Thinking:** To analytically synthesize information.
4. **Technological competence:** To be a literate operator of technology.
5. **Culturally Aware:** To be considerate and selflessly work with others.
6. **Initiative:** To be motivated and self-directed by applying goal setting techniques, organizing and managing my time efficiently, and assuming responsibility for my life.

**Mr. Warren's Work Ethic Code:**

1. **Integrity:** I will be honest in everything I do, even to my own hurt.
2. **Respect:** I will respect all people equally.
3. **Initiative:** I will be self-motivated and not wait to be told. I will look for what needs to be done next and do it.
4. **Balance:** I will keep a proper balance in my life and serve my wife and children above all else. Work will not dominate my life.
5. **Diligence:** I will work hard, stay focused, not take meaningless short cuts, and see a job through until it is completed with excellence in a safe, efficient, and timely manner.
6. **Communication:** I will communicate clearly with people.
7. **Time management:** I will manage my time wisely and not engage in activities that are not beneficial for the well-being of others or myself.
8. **Excellence:** I will pursue excellence in everything I do and will always seek to *do things right*.
9. **Humility:** I will have the heart of a servant and work primarily for the blessing of others, not for my financial gain. I will work for the profit of others, be open to criticism, seek advice, and always be hungry to learn.
10. **Worship:** I will do everything as an expression of my adoration for Jesus.

**Common standards:**

1. Integrity
2. Respect
3. Law abiding
4. Excellence
5. Competency

## Chapter 28

**I-Management****Introduction:**

People who have a good work ethic need little managing. They look for what needs to be done and do it before having to be told. They have learned I-management. In the first ten years of the new millennium, everything was about the I (me, my, mine): I-pods, I-pads, I-tunes, etc. Well, if you are going to have a good work ethic, you are going to have to learn I-management. .

**I-Management:**

When developing your work ethic, consider how you will manage yourself. Take a look at the following I-management principles and ask yourself which you will apply to your life and how.

1. ***I*ntegrity**: Being honest and sincere, even to your own hurt. Having strong moral character.
2. ***I*nitiative**: Being self-motivated. Not waiting to be told to do some. Being aware and active.
3. ***I*nnovation**: Having the ability to improve or advance a method. Being able to think outside the box and discover more efficient ways of accomplishing something.
4. ***I*nfluence**: Having an effect on others (hopefully positive). The ability to lead by example and motivate others to accomplish a task.
5. ***I*ntelligence**: Being a life-long learner. Always seeking to learn more.
6. ***I*nterdependence**: The ability to depend on the gifts, abilities, and talents of others. To recognize the importance and value of team members to help you do something better.
7. ***I*ntuition**: The ability to foresee what might happen if certain actions occur.

Chapter 29

**Stress Management**

**Introduction:**

A part of having a good work ethic is how you manage stress. It's hard to be an efficient, dedicated, hard working individual if you constantly live in crisis. We've all heard it before: Stress is the number one killer in America. And, if it's not killing you, it's destroying you. "The American Medical Association has noted that stress was the basic cause of more than 60 percent of all human illness and disease" (<http://www.lesstress.net/stress-facts.htm>). Are we doomed? Not hardly. Stress is manageable.

**Causes of Stress:**

Life can be stressful, but you can keep it from ruining your life by learning how to control these three major causes of stress: Feeling like you're out of control, Fear, and Poor time management.

*Out of control:*

There are times we *feel* out of control, and other times we *truly are* out of control. The first is the easiest to manage.

We *feel* out of control when a situation occurs that prevents us from doing what we want. When we must complete a project, for instance, we are unable to do the fun things we want to do. Chores, also, interrupt our plans for the day. When we say, "I would much rather be doing..." and we can't do it, here comes the stress. Some of the best advice here is simply, "Suck it up princess." Life's hard and we don't always get to do what we want. You can complain, mope, or pout, but these only increase our stress. Simply, zip it and get 'er done. Stop whining and get working. Stress will increase the more you put it off.

Still other times, life truly is out of our control. There are keys to managing these unbearable moments, but that is beyond the scope of this class. For now, it will suffice to say, it is possible to have peace even in those out of control moments. One thing is for certain though. Don't add fear to stress. That's a killer.

*Fear:*

Life happens, and so does stress. We will not always be in control of our lives, but we are in control of how we respond. What will make it worse is fear. You see, being out of control is one thing, but when you add fear to it, it's an altogether different beast. Fear will always tell us the worst will happen. Deadlines, for instance, produce stress, but the fear that missing the deadline will ruin your life compounds it. Do not let fear play with you. Few things will actually ruin your life (and most of them are illegal or immoral anyway). When stress comes, don't believe the lies that come with it. Your life will not be ruined. It may be changed, but it will not be ruined.

*Poor time management:*

Stress, in many cases, is self-induced. It can be avoided. Often, stress comes because we have managed our time so poorly. When we do, we create a sense of urgency that puts us in stress mode. Few things are actually urgent by themselves, but our poor time management creates a crises and BAM, here comes the stress. Learn to manage your time. Don't procrastinate, and don't even deceive yourself into thinking, "but I do things so much better when they are last minute." That is such a lie. Learn to know the difference between what is urgent and what is not, what is important and what is not. Below is a chart that will help you.

The key is to live most of your time in quadrant II and reward yourself with quadrant IV. Sadly, many people live most of their time in quadrant IV, and are rewarded with quadrant I living (and that's miserable).

	Urgent	Not Urgent
Important	<b>I</b> - Crisis - Pressing Issues - Deadlines - Meetings	<b>II</b> - Preparation - Planning - Prevention - Relationship building - Personal Development
Not Important	<b>III</b> - Interruptions - Some mail - Many popular activities	<b>IV</b> - Trivia - Some phone calls - Excessive TV/Games - Time wasters





# appendix



## Consent to Use Power Tools

As a means of impressing upon your child the importance of woodshop safety, we are requesting that you review unit one, *Safety*, with your child and sign the form below. This form authorizes your child to use the wood shop equipment, power tools, and woodworking machinery after he/she has been certified to do so. No student will at any time be forced to use the power equipment. However, no student will be permitted to use power equipment unless this form is properly signed and filed in the Valley Oaks Charter School (VOCS) office.

### Agreement

With my signature below, I hereby agree that my child, \_\_\_\_\_ may receive instruction and training in the VOCS woodshop to use the shop equipment, power tools, and woodworking machines provided in the shop. I further agree to allow my child to use the shop equipment, power tools, and woodworking machines after he/she has been certified to do so. In the event of an accident occurring because my child or another student did not follow the safety rules, instructions, or guidelines, I shall not hold VOCS or the instructor responsible. I shall urge my child to cooperate fully with the safety guidelines set forth by the VOCS woodshop department.

Signed: \_\_\_\_\_ Date: \_\_\_\_\_

### Student's Declaration

With my signature below, I declare that I have been properly instructed in shop safety, reviewed unit one, *Safety*, with my parent/guardian, and agree to follow the guidelines of the VOCS woodshop. I further agree to use machinery only after I have been certified on the piece I intend to use and have first asked the teacher for permission. While using the shop equipment, power tools, and woodworking equipment, I will always follow the safety precautions and use the proper technique required by each tool. If, at any time, I am unsure, uncertain, or insecure about using any piece of shop equipment, a power tool, or a woodworking machine, I will inform the teacher of how I feel. I further agree that I will always do my best to protect my safety and the safety of others.

Signed: \_\_\_\_\_ Date: \_\_\_\_\_

### Teacher Authorization

Signed: \_\_\_\_\_ Date: \_\_\_\_\_

## Basic Woodworking

A score of 75% or greater is required before advancing to the next skill set

Name: \_\_\_\_\_ Date: \_\_\_\_\_

Project: \_\_\_\_\_

Grading Scale:            1= Poor    2= Needs work    3= Good    4= Well done    5= Excellent

### Planning and preparation (25 possible points)

A. Plans	Score
1. Views (front, top, left side, section)	_____
2. Line quality, neatness, and orderliness	_____
3. Scaling	_____
4. Title block	_____
5. Dimensioning and notations	_____
	Total: _____

### Construction (25 possible points)

A. Project Building Comprehension	Score
1. Skillful and safe use of required tools	_____
2. Understands woodworking techniques and plan reading	_____
 B. Assembly	
1. Dimensions and image match plans	_____
2. Construction is square	_____
3. Joinery is strong, clean, and smooth	_____
	Total: _____

### Finish (25 possible points)

A. Surface preparation	Score
1. No visible dents, scratches, mill marks, etc.	_____
2. Sanding (smooth, edges softened, etc.)	_____
3. No visible glue marks. Proper use of filler/plugs/caps.	_____
 B. Finishing	
1. Stain	_____
2. Finish top coats	_____
	Total: _____

### Overall Work Ethic (25 possible points)

A. Cooperation (does share of cleaning, picks up after self, helpful)	_____
B. Diligence (hard working, industrious, self-motivated, initiative)	_____
C. Behavior (serious, focused, punctual, not distracting)	_____
D. Excellence (overall project appearance, pursuit of craft, driven)	_____
E. Integrity (honest, does own work, honors classmates, reliable)	_____
	Total: _____

**Final Score:** \_\_\_\_\_